

TekFlex-85T Pro

79285 User Manual

TekFlex-85T Pro

8x5 Universal HyFlex Matrix Presentation Switcher



All Rights Reserved

Version: 79285_2022V1.0

www.tekvox.com

TekFlex-85T Pro

79285 User Manual

Preface

Read this user manual carefully before using the product. Pictures shown in this manual are for reference only. Different product model specifications may vary.

This manual is only for operation instruction, please contact the local distributor for maintenance assistance. The functions described in this version were updated November, 2022. In order to continue improving the product, we reserve the right to make function or parameter changes without notice or obligation. Please refer to the dealers for the latest details.

FCC Statement

This equipment generates, uses and can radiate radio frequency energy and, if not installed and used in accordance with the instructions, may cause harmful interference to radio communications. It has been tested and found to comply with the limits for a Class A digital device, pursuant to part 15 of the FCC Rules. These limits are designed to provide reasonable protection against harmful interference in a commercial installation.

Operation of this equipment in a residential area is likely to cause interference, in which case the user at their own expense will be required to take whatever measures may be necessary to correct the interference.

Any changes or modifications not expressly approved by the manufacture would void the user's authority to operate the equipment.



TekFlex-85T Pro

79285 User Manual

Safety Precautions

To ensure the best performance from the product, please read all instructions carefully before using the device. Save this manual for further reference.

- Unpack the equipment carefully, and save the original box and packing material for possible future shipment
- Follow basic safety precautions to reduce the risk of fire, electrical shock, and injury
- Do not dismantle the housing or modify the module (electrical shock or burn hazard)
- Using supplies or parts not meeting the products' specifications may cause damage, deterioration, or malfunction
- Refer all servicing to qualified service personnel
- To prevent fire or shock hazard, do not expose the unit to rain or moisture, or install this product near water
- Do not put any heavy items on the product's power cable
- Do not remove the housing of the device, as opening or removing the housing may expose you to dangerous voltages or other hazards
- Install the device in a place with sufficient ventilation to avoid damage caused by overheating
- Keep the module away from liquids
- Spillage into the housing may result in fire, electrical shock, or equipment damage. If an object or liquid falls or spills on to the housing, unplug the module immediately.
- Do not twist or pull by force ends of the optical cable. It can cause malfunction.
- Do not use liquid or aerosol cleaners to clean this unit. Always unplug the power to the device before cleaning.
- Unplug the power cord when left unused for a long period of time
- Information on disposal for scrapped devices: do not burn or mix with general household waste, please treat them as normal electrical wastes

Table of Contents

1. Product Introduction	6
1.1 Features	6
2. Specifications	7
3. Panel Description	10
3.1 Matrix Switcher Front Panel	10
3.2 Matrix Switcher Rear Panel	11
3.3 Receiver Front Panel	12
3.4 Receiver Rear Panel	12
3.5 System Connection	13
3.6 System Flow Diagram	13
4. Front Panel Control	14
4.1 Multiview Mode Selection	14
4.2 Full-Screen Setting	14
4.3 Audio Control	14
4.4 Video Signal Switching	15
4.4.1 In Multiview modes	15
4.4.2 In Full-Screen mode	15
4.5 Switching Status	15
5. GUI Control	16
5.1 Control Tab	17
5.1.1 Video Control	17
5.1.2 Audio Control	18
5.2 Multiview Tab	19
5.2.1 Pre-Defined Multiview Mode	19
5.2.2 User-Defined Multiview Mode	21
5.3 Audio Tab	22
5.3.1 Input Tab	22
5.3.2 Output Tab	23

TekFlex-85T Pro

79285 User Manual

5.3.3 Matrix Mixer Tab	24
5.4 CEC Tab	25
5.4.1 Source Control.....	25
5.4.2 Display Control	25
5.4.3 User-Defined Control	26
5.5 RS232 Tab	27
5.6 EDID Tab	28
5.6.1 EDID Copy	28
5.6.2 EDID Setting.....	28
5.6.3 EDID Upload.....	29
5.7 Network Tab	29
5.8 Tags Tab	30
5.8.1 Input & Output Tags	30
5.8.2 Multiview Mode Tags	30
5.9 Security Tab.....	31
5.10 Additional Tab	32
5.10.1 Additional Settings.....	32
5.10.2 HDBaseT Cable Link Quality	32
6. IR Remote Control	33
7. RS232 Control	34
7.1 Audio and Video Switching	35
7.2 Audio Settings	36
7.3 Function Settings	41
7.4 Window Settings	45
7.5 CEC Function Commands	47
7.6 System Function Commands.....	50
7.7 Special Commands.....	50
8. Firmware Upgrade	52
8.1 Switcher Firmware	52
8.2 HDBaseT Receiver Firmware	52

TekFlex-85T Pro

79285 User Manual

1. Product Introduction

The TekFlex-85T Pro is an 8x5 presentation matrix switcher designed to simplify the implementation of large distance learning and HyFlex systems. The TekFlex-85T Pro includes dual HDBaseT outputs for multi-display systems, a quad-multiview camera switcher with USB capture, and seven HDMI inputs & 1 USB-C input with 60W charging. Matrix switching ensures that any input can be routed to any output, and the switcher includes twelve flexible multiview configurations for displaying up to four sources at once, as well as an auto-switching mode.

The built-in, multi-host USB 3.0 KVM BYOM from an in-room PC, 2 separate HDMI laptops, and a USB-C laptop. The TekFlex-85T Pro also includes an internal DSP with four microphone inputs (each with toggleable phantom power) for mixing microphones, providing speech reinforcement, echo cancellation, and AEC reference for ceiling microphones. Finally, the TekFlex-85T Pro includes a PoE-capable internal network switch, which drastically reduces the number of network connections needed for larger systems. The camera multiviewer supports Side-by-Side (SBS) and Picture-in-Picture (PIP) usage of system cameras for conferencing. The internal network switch reduces network drops needed, and supports PoE for powering a connected controller or touchscreen.

With an incredible array of advanced features packed into a 1RU form factor, the TekFlex-85T Pro represents the pinnacle of comprehensive, integrated A/V for distance learning and HyFlex systems.

1.1 Features

- 7 HDMI inputs and 1 USB-C input with 60W charging
- 3 HDMI outputs, and 2 HDBaseT outputs with 100m (328ft) transmission range
- Route any input to any output with 8x5 matrix switching
- View up to four sources at once with 12 different flexible multiview configurations
- Independent audio input selection during multiview operation
- Supports output resolutions up to 4Kx2K @ 60Hz
- Default video output resolution is 1080p @ 60Hz
- Independent EDID settings for all inputs; default is 1080p @ 60Hz
- Integrated 4-host USB 3.0 KVM for BYOD or PC-based video conferencing
- USB capture routed to Device side of KVM for easy use in video conferences
- Bi-directional USB 3.0 at switcher and receiver (USB over HDBaseT is limited to USB 2.0)
- Automatic bridging of USB hub to a connected USB-C laptop
- Supports both mic and line level audio inputs

TekFlex-85T Pro

79285 User Manual

- 4-Microphone DSP with selectable phantom power and built-in AEC
- Controllable via RS232, IR remote, front panel buttons, web UI, or TCP/IP commands
- RS232 and TCP/IP commands use a unique, easy-to-use ASCII protocol
- Supports RS232 and CEC control of displays and source devices with user-defined commands
- Supports custom RS232 commands to be sent to display on device power on/off
- Receiver supports 12 ~ 48V PoC power
- Bridged LAN network uses single network connection for switcher and 3rd-party devices at receiver

2. Specifications

Switcher	
Inputs	7 HDMI (19-pin, Female) 1 USB-C (USB Type-C, Female) 4 MIC/Line In (3-pin Phoenix, balanced mono)
Input Resolution	HDMI: Up to 4Kx2K @ 60Hz 4:4:4, HDR 10 USB-C: Up to 4Kx2K @ 60Hz 4:4:4
Outputs	2 HDMI (19-pin, Female) 1 HDMI Multiview (19-pin, Female) 2 HDBaseT (RJ45, Female) 1 Main (3-pin Phoenix, balanced mono) 1 AEC Reference (3-pin Phoenix, balanced mono)
Output Resolution	HDMI: Up to 4Kx2K @ 60Hz 4:4:4 HDBaseT: Up to 4Kx2K @ 60Hz 4:2:0
Video Standards	HDMI: 2.0 HDCP: 2.2
Frequency Response	20Hz ~ 20kHz, ±3dB
Input Impedance	> 10kΩ
Audio Input Formats	Audio/LINE/MIC: PCM 2.0 HDMI Audio: PCM 2.0 48K
Max Output Level	2.0 ± 0.1Vrms
Total Harmonic Distortion + Noise (THD+N)	< 0.05%, 20Hz to 20kHz bandwidth, 1kHz sine at 0dBFS level (or max level)
Signal-to-Noise Ratio (SNR)	> 80dB, 20Hz to 20kHz bandwidth
L-R Level Deviation	< 0.3dB, 1kHz sine at 0dBFS level (or max level before clipping)
Output Load Capability	1kΩ and higher (Supports 10x paralleled 10kΩ loads)
Noise Level	-80dB

TekFlex-85T Pro

79285 User Manual

Switcher	
Control Ports	3 PC (USB 3.0 Type-B, Female) 3 Device (USB 3.0 Type-A, Female) 1 USB-C (Type-C, Female) 1 IR EYE (3.5mm mini jack) 1 RS232 Main (3-pin Phoenix) 2 RS232 Passthrough (3-pin Phoenix, direct connection to HDBaseT lines) 2 TCP/IP (RJ45, Female, 1 with PoE)
Maximum Transmission Distance	4Kx2K @ 60Hz 4:2:0 / 4Kx2K @ 30Hz 4:4:4 / 1080p @ 60Hz: 328 ft (100m)
Bandwidth	18 Gbps
Operating Temperature	23 ~ 131°F (-5 ~ 55°C)
Storage Temperature	-13 ~ 158°F (-25 ~ 70°C)
Humidity	10 ~ 90%, non-condensing
Power Supply	100 ~ 240 VAC, 50/60Hz
Power Consumption	158W (max)
USB-C Charging Power Consumption	60W (max)
Product Dimensions	17.2" (436mm) x 1.7" (44mm) x 14.2" (360mm)
Product Weight	12.1 lbs. (5.4kg)

Receiver	
Inputs	1 HDBaseT (RJ45, Female)
Outputs	1 HDMI (Type-A, Female) 1 Toslink (SPDIF, PCM 2.0)
Input Resolution	Up to 4Kx2K @ 60Hz 4:2:0
Output Resolution	Up to 4Kx2K @ 60Hz 4:4:4
Video Standards	HDMI: 2.0 HDCP: 2.2
Max Output Level	± 0.3dBFS
Frequency Response	20Hz to 20kHz, ±1dB
Total Harmonic Distortion + Noise (THD+N)	< 0.05%, 20Hz to 20kHz bandwidth, 1kHz sine at 0dBFS level (or max level)
Signal-to-Noise Ratio (SNR)	> 90dB, 20Hz to 20kHz bandwidth
Crosstalk Isolation	< -70dB, 10kHz sine at 0dBFS level (or max level before clipping)
Noise Level	- 90dB

TekFlex-85T Pro

79285 User Manual

Control Ports	1 PC (USB 3.0 Type-B, Female) 3 Device (USB 3.0 Type-A, Female) 2 TCP/IP (RJ45, Female, 1 with PoE) 2 IR (In/Out, 3.5mm mini jack) 1 RS232 (3-pin Phoenix)
Maximum Transmission Distance	4Kx2K @ 60Hz 4:2:0 / 1080p @ 60Hz: 328 ft (100m)
Bandwidth	18 Gbps
Operating Temperature	23 ~ 131°F (-5 ~ 55°C)
Storage Temperature	-13 ~ 158°F (-25 ~ 70°C)
Power Supply	Power over Cable (PoC) 12 ~ 48V range
Power Consumption	10W (max)
Product Dimensions	6.61" (168mm) x 0.91" (23mm) x 5.31" (135mm)
Product Weight	1.1 lbs. (500g)

TekFlex-85T Pro

79285 User Manual

3. Panel Description

3.1 Matrix Switcher Front Panel

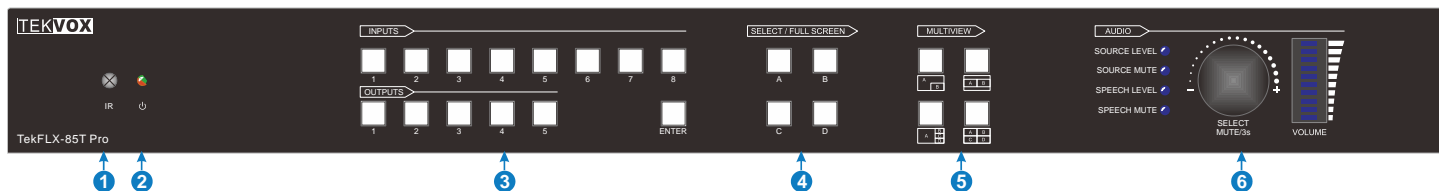

1. **IR:** Built-in IR sensor for control via IR remote
2. **Power Indicator:** LED indicator; turns green when switcher is powered on, turns red when in Standby Mode
3. **Inputs and Outputs:**
 - a. **Inputs:** Eight white buttons w/ blue LED backlight for source channel selection
 - b. **Outputs:** Five white buttons w/ blue LED backlight for output channel selection
 - c. **Enter:** Press to confirm video switching
4. **Select / Full Screen:** Four white buttons with blue LED backlight for selecting a source to show full-screen when in Multiview Mode
5. **Multiview:** Four white buttons with blue LED backlight for Multiview Mode selection
6. **Audio:**
 - a. Two blue audio indicators for Source
 - b. Two blue audio indicators for Speech
 - c. One array audio volume/gain indicator
 - d. One audio source select/control knob
 - i. Press once to switch between controlling Source and Speech volume/gain
 - ii. Press and hold for at least 3 seconds to mute the selected audio channel; rotate knob to un-mute

TekFlex-85T Pro

79285 User Manual

3.2 Matrix Switcher Rear Panel

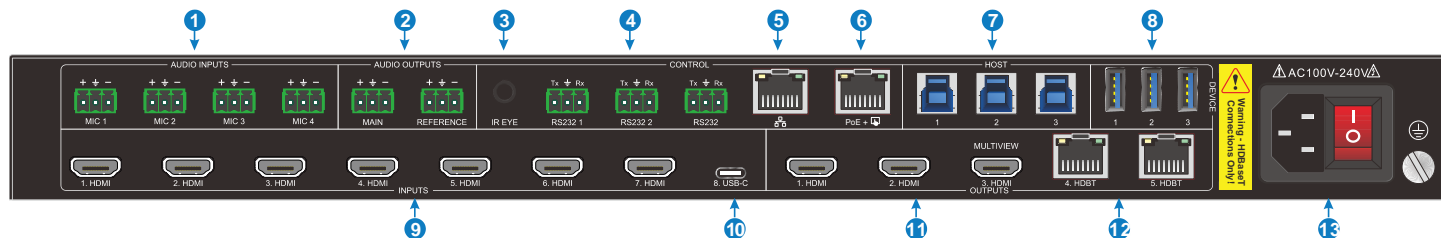

1. **Audio Input:** Four 3-pin terminal blocks for microphone inputs
2. **Audio Output:**
 - a. **Reference (Balanced Mono):** Audio output of all sound corresponding to the selected input
 - b. **Main (Balanced Mono):** Audio output of Volume Mixer, includes mixed Source and Speech audio
 - c. **HDBaseT Out 4:** Audio embedded in HDBaseT Output 4; can be
 - i. Audio output of all sound corresponding to the selected input, OR
 - ii. Audio output of Volume Mixer, includes mixed Source and Speech audio
 - d. **HDMI Out 3:** Audio output of Volume Mixer, includes mixed Source and Speech audio
3. **IR Eye:** 3.5mm stereo jack for connecting an IR receiver to control the matrix via IR remote
4. **RS232:**
 - a. Two 3-pin terminal blocks for RS232 passthrough directly to HDBaseT outputs
 - i. RS232-1 ↔ HDBaseT Out 4
 - ii. RS232-2 ↔ HDBaseT Out 5
 - b. One 3-pin terminal block for RS232 control of matrix switcher
5. **LAN:** Connection for web UI and TCP/IP control
6. **Ethernet:** Connection for Ethernet passthrough; supports 30W PoE
7. **Host:** Three Type-B USB 3.0 ports for connecting PCs, laptops, or other USB host devices
8. **Devices:** Three Type-A USB 3.0 ports (5V, 900mA) for connecting USB devices
9. **HDMI In:** Seven HDMI 2.0 inputs; support resolutions up to 4Kx2K @ 60Hz 4:4:4, HDR, Dolby Vision
10. **USB-C In:** USB-C inputs, supports 4Kx2K @ 60Hz 4:4:4 video, provides up to 60W charging to connected devices
11. **HDMI Out:** Three HDMI outputs for connecting to local HDMI displays
12. **HDBT Out:** Two HDBaseT outputs for connecting to distant displays via HDBaseT receivers
13. **AC Inlet:** AC 100~240V power supply

TekFlex-85T Pro

79285 User Manual

3.3 Receiver Front Panel



1. **Power LED:** Lights up red when receiver is powered on
2. **HDMI LED:** Lights up green when there is an active HDMI output signal
3. **PC:** Type-B USB 3.0 port for connecting PCs, laptops, or other USB host devices; connected equipment can access all USB devices (e.g. mouse, keyboard, etc.) connected to Type-A ports
4. **Devices (1~3):** Three Type-A USB 3.0 ports for connecting USB devices
5. **FW:** Micro-USB port for upgrading device firmware

3.4 Receiver Rear Panel

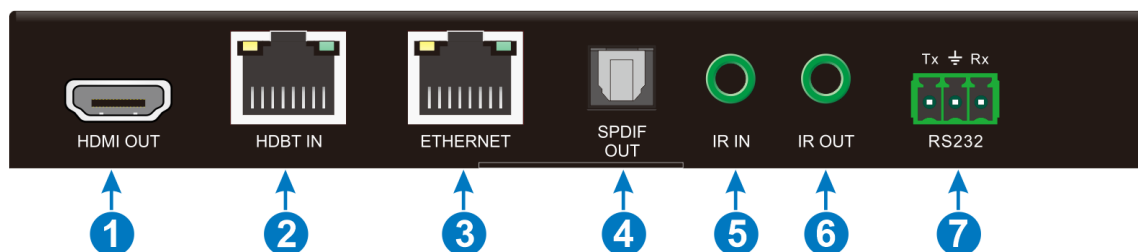

1. **HDMI Out:** HDMI video output for connecting to display device
2. **HDBaseT In:** Connects to an HDBaseT output port of the matrix switcher via a CAT cable. The orange LED indicator lights up when there is a valid HDBaseT link between the switcher and receiver. The green LED indicator lights up when the incoming video contains HDCP content.
3. **Ethernet:** RJ45 port for network signal extension; when the TCP/IP port of the matrix switcher is connected to a network, the network signal will be extended to this port via HDBaseT tunneling.
4. **SPDIF Out:** Audio output for connecting de-embedded audio to amplifier or speakers
5. **IR In:** Connect to IR receiver for IR passthrough
6. **IR Out:** Connect to IR emitter for IR passthrough
7. **RS232:** Connect to a third-party controller or display device for RS232 passthrough control

TekFlex-85T Pro

79285 User Manual

3.5 System Connection

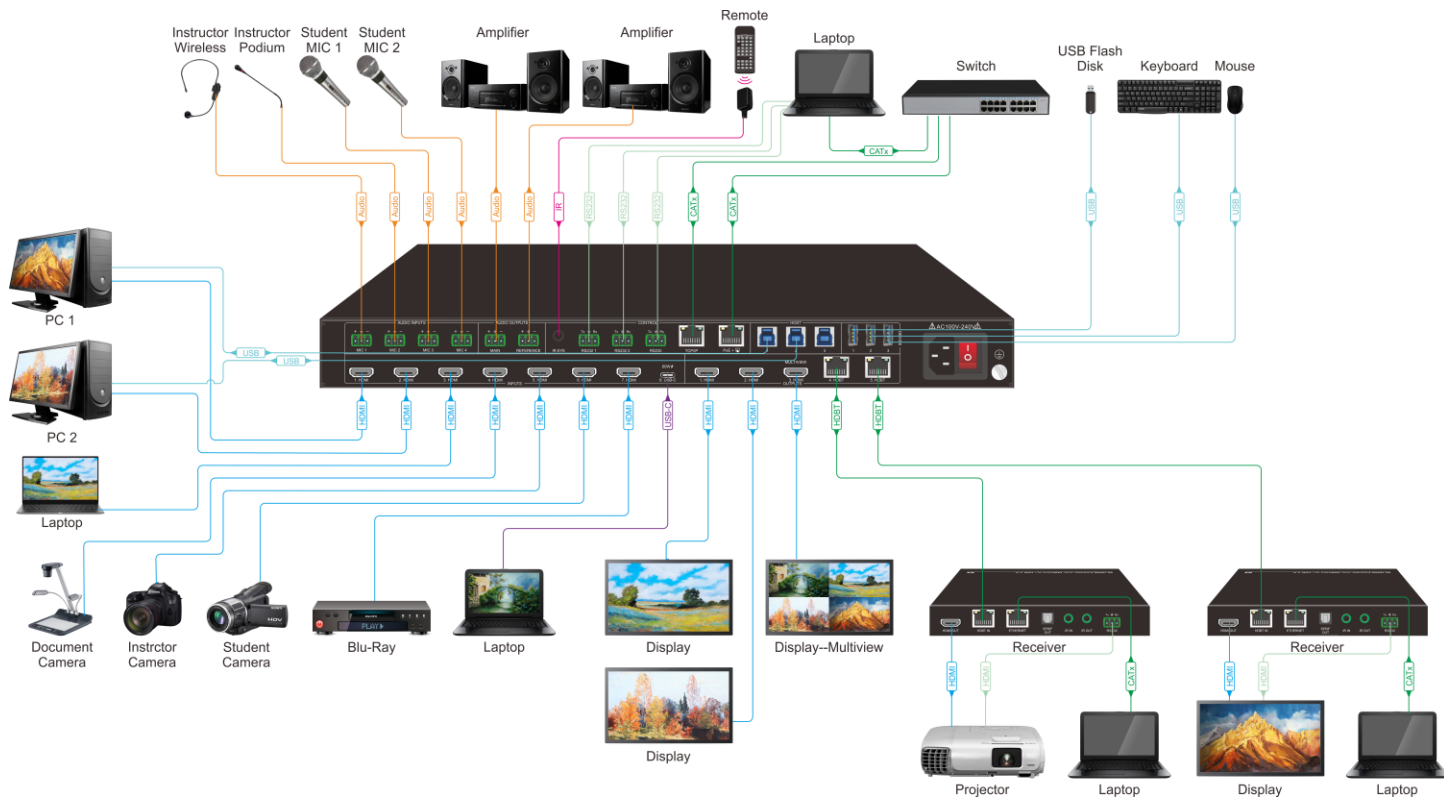

3.6 System Flow Diagram

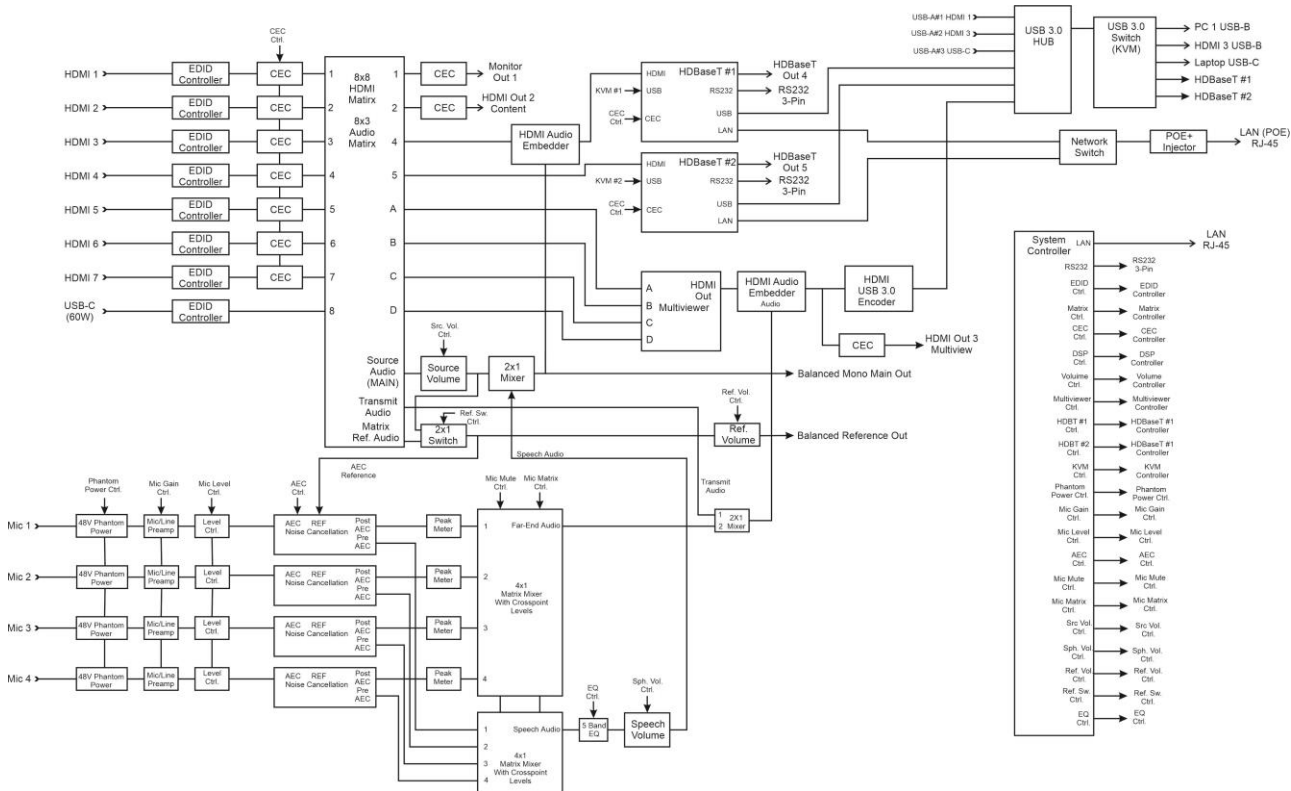

TekFlex-85T Pro

79285 User Manual

4. Front Panel Control

4.1 Multiview Mode Selection

There are four built-in Multiview Modes which can be selected via the front panel buttons.

Input 1 → Window A
Input 2 → Window B
Input 3 → Window C
Input 4 → Window D

The view buttons' LEDs (A~D) will turn blue

When switching to two-window (A&B) mode, the corresponding mode LED will turn blue, and the window A and B LEDs turn blue. The factory default correspondence between the two input sources and the two output windows is:

Input 1 → Window A
Input 2 → Window B

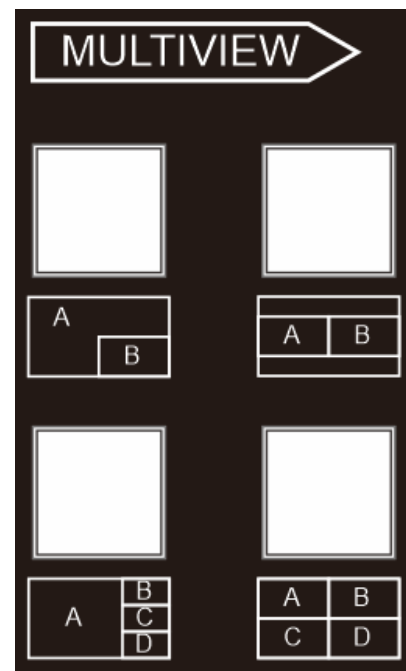

4.2 Full-Screen Setting

The factory default mode is Full-Screen, and the correspondence is:
Input 1 → Window A.

In Multiview mode, press the Window A~D buttons to select the corresponding window to display in full screen. The corresponding input source button LED and window button A LED illuminate blue, and other window buttons and previous Multiview mode button LEDs will go out.

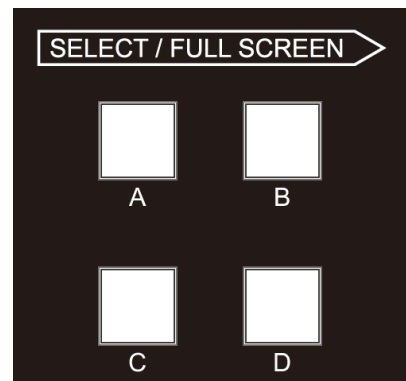

4.3 Audio Control

By default, the HDMI and HDBT output audio follows the video source in Full-Screen mode, but in the Multiview modes there will be no output audio. The audio source can be changed via GUI or RS232 commands.

Press the volume knob to select Source level or Speech level.

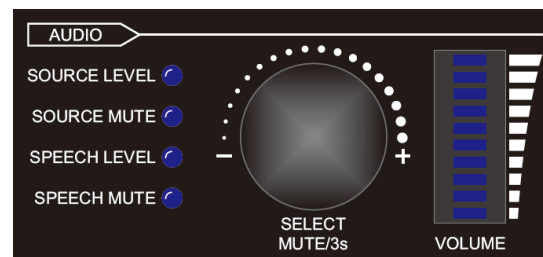

Rotate the knob to increase or decrease the volume of the selected audio. Press and hold the knob for at least 3 seconds to mute the selected audio; rotate the knob to un-mute.

TekFlex-85T Pro

79285 User Manual

4.4 Video Signal Switching

4.4.1 In Multiview modes

Operation: Input # + Output # + Window # + Enter

Example: Switch Input 1 to Window B on Output 3:

Press "Input 1" (The Input 1 LED will turn blue) → Press "Output 3" (The Output 3 LED will turn blue, and the Window A~D LEDs will flash) → Press "Window B" (The A, C, and D LEDs will go out) → Press ENTER (The Input 1, Output 3 and Window B LEDs will flash three times. The Input 1 and Output 3 LEDs will then go out, and the Window A~D LEDs will turn blue)

4.4.2 In Full-Screen mode

Operation: Input # + Output # + Enter

Example: Switch Input 3 to full-screen on Output 3:

If the current status is set to full screen Window A, press "**Input 3**" + "**Output 3**" to switch the HDMI Input 3 to Window A. The Input 3 and Window A LEDs will then turn blue.

4.5 Switching Status

In Multiview mode (Window A, B, C, and D LEDs will turn blue)

Operation: Press and hold **Window #** button for at least 3 seconds.

Example: Press and hold **Window B** button for at least 3 seconds (A, C, and D LEDs go out, and then the corresponding input source LED will turn blue). After 3 seconds, A, B, C, and D LEDs will turn blue, and the input LED will go out.

TekFlex-85T Pro

79285 User Manual

5. GUI Control

The switcher can be controlled via TCP/IP. The default IP settings are:

IP Address: 192.168.0.178

Subnet Mask: 255.255.255.0

Type **192.168.0.178** in a web browser, and it will enter the log-in page below:

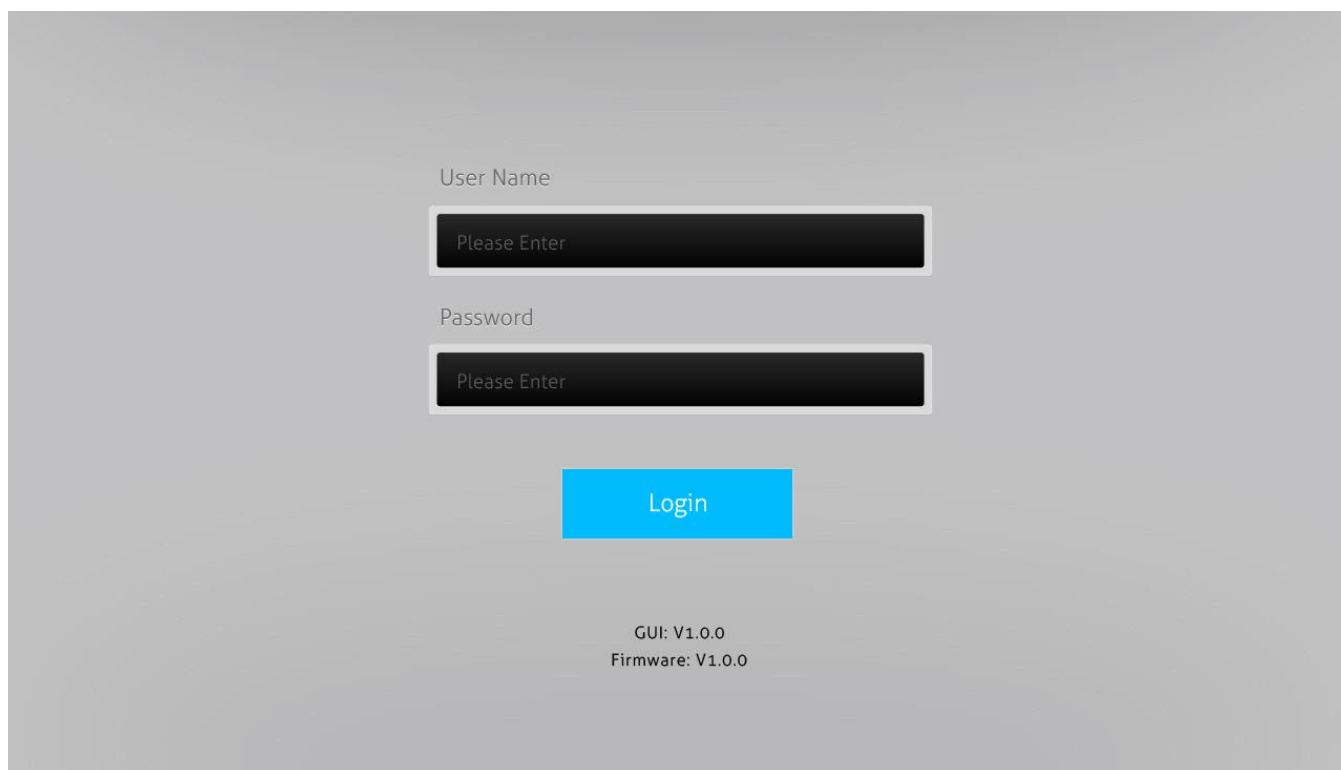

User Name

Please Enter

Password

Please Enter

Login

GUI: V1.0.0
Firmware: V1.0.0

Default Username: admin

Default Password: admin

Type the username and password, then click "Login." The GUI will open to the section for video switching control.

TekFlex-85T Pro

79285 User Manual

5.1 Control Tab

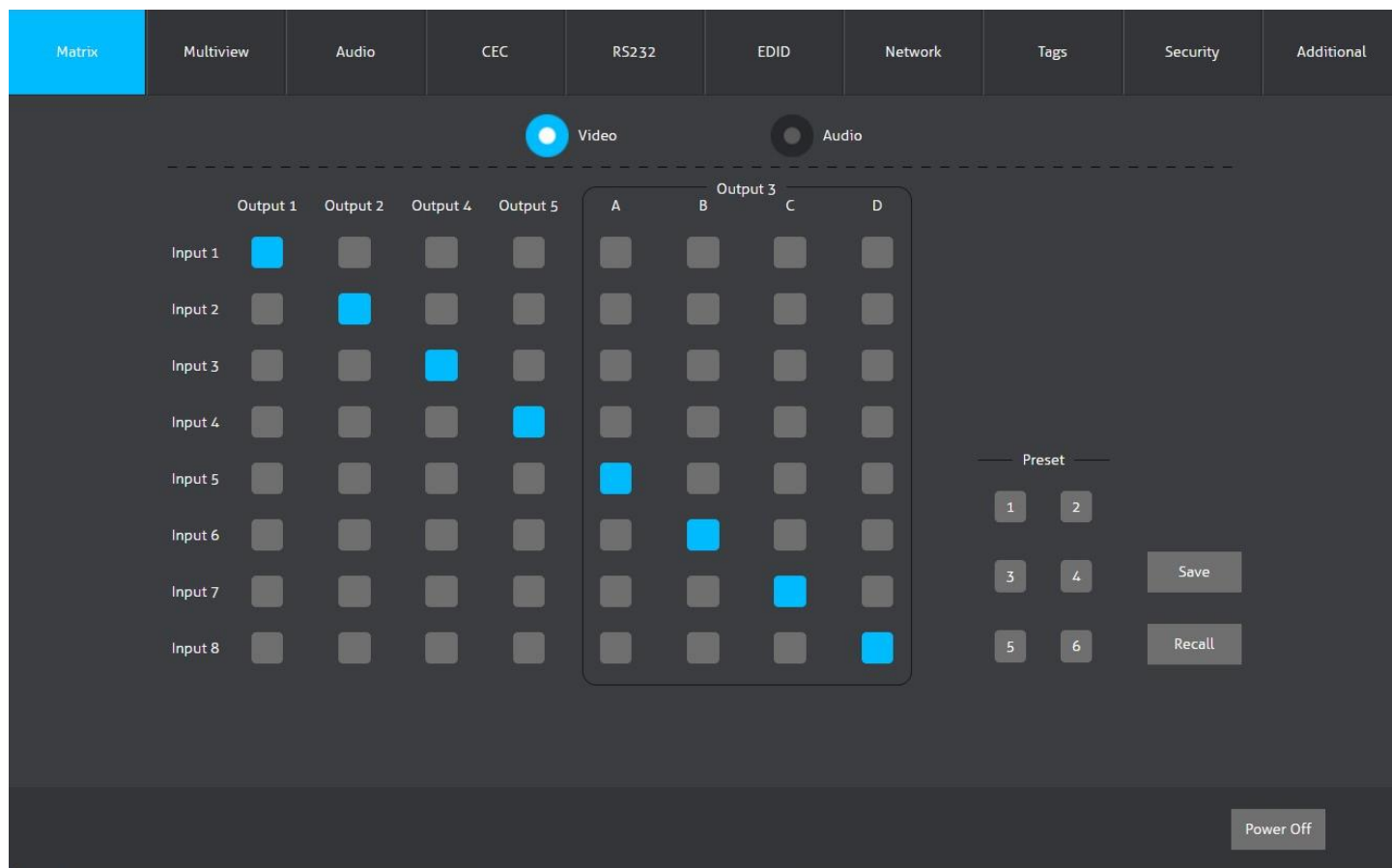

5.1.1 Video Control

Use the 8x8 button grid on the page to set which inputs are directed to which outputs. For example, clicking the button on the Input 1 row and Output 1 column, directs input 1 to output 1.

Use the 6 numbered buttons under "Preset" to save and load layout presets.

- To save a given layout, set the inputs and outputs as desired, click one of the numbered Preset buttons, then click "Save"
- To load a previously-saved layout, click the number of the desired preset, then click "Recall"



TekFlex-85T Pro

79285 User Manual

5.1.2 Audio Control

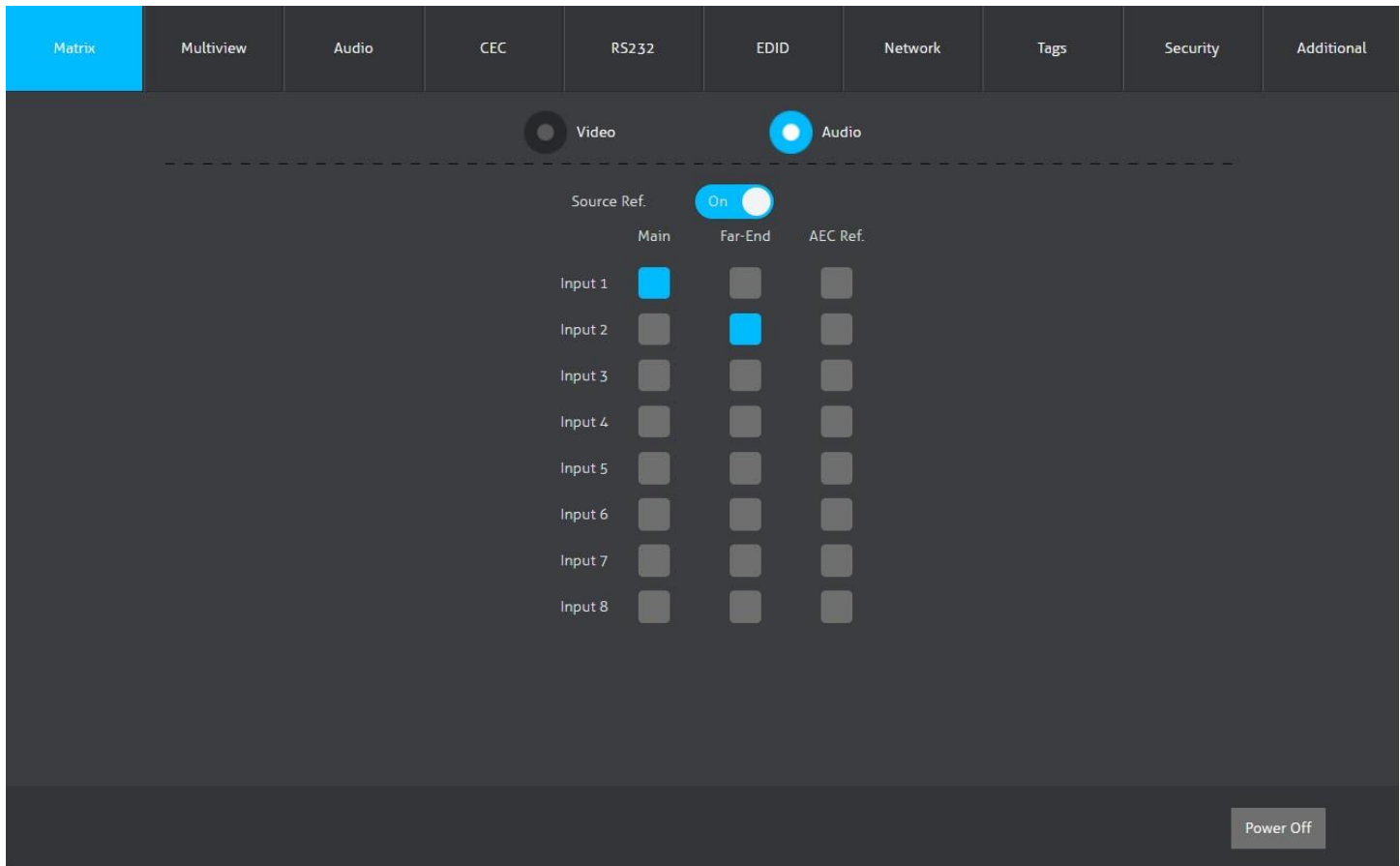

Use the 8x3 button grid on the page to set which audio inputs are directed to which outputs. For example, clicking the button on the Input 1 row and the AEC Ref. will set HDMI Input 1's audio as the AEC reference signal.

Source Ref: When this setting is ON, the AEC Reference will automatically follow Main, but will not light up. When this setting is OFF, the AEC Reference can be selected independently, and will not automatically follow any other signals.

TekFlex-85T Pro

79285 User Manual

5.2 Multiview Tab

5.2.1 Pre-Defined Multiview Mode

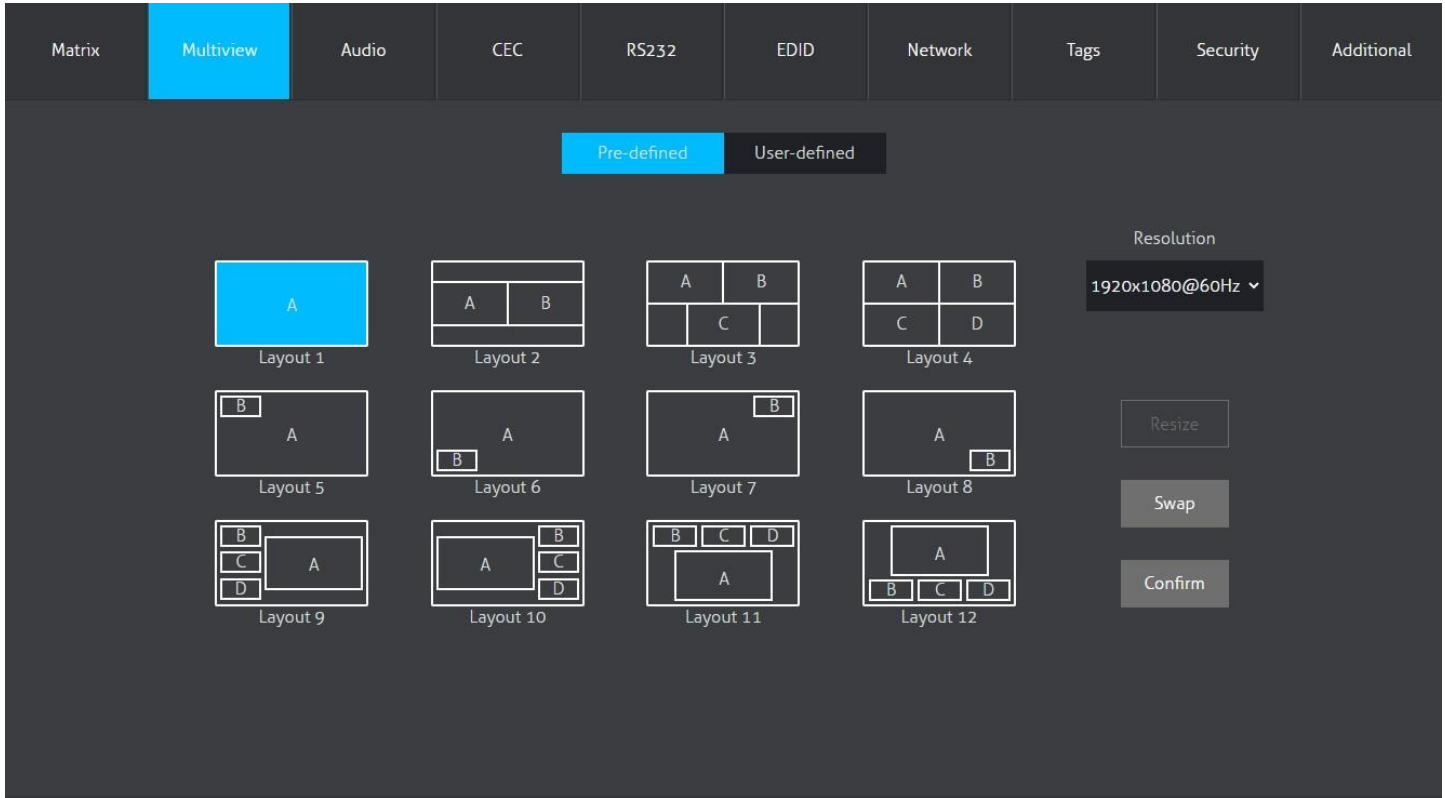

Up to 12 different Multiview Modes can be selected

Resize: Click this button to adjust the window size¹

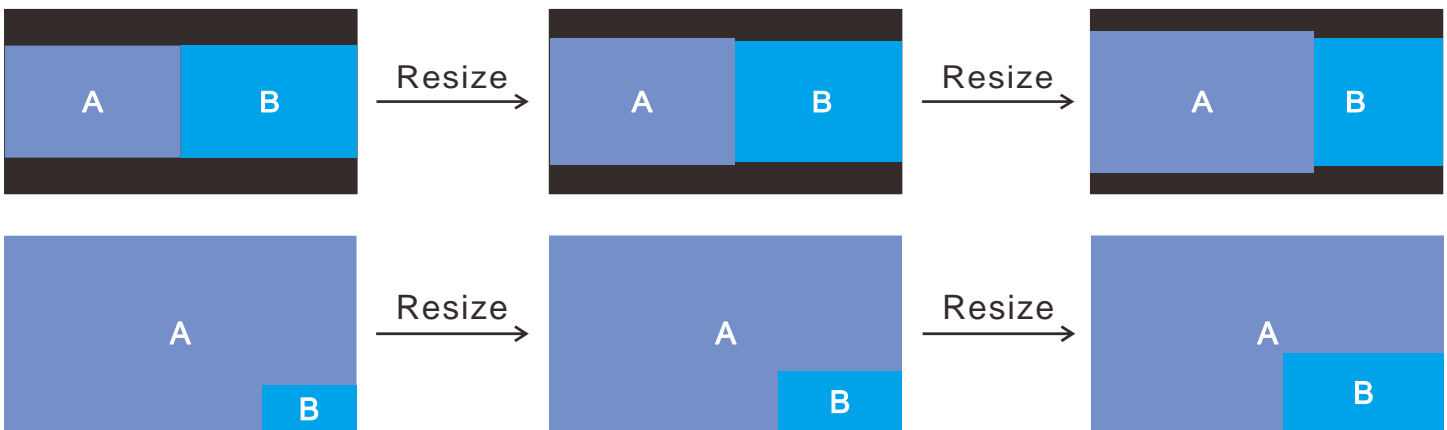

¹ Only Layout 2, and Layouts 5-12 can be adjusted in this way

TekFlex-85T Pro

79285 User Manual

Swap: Press this button to cycle through the video sources displayed in each window

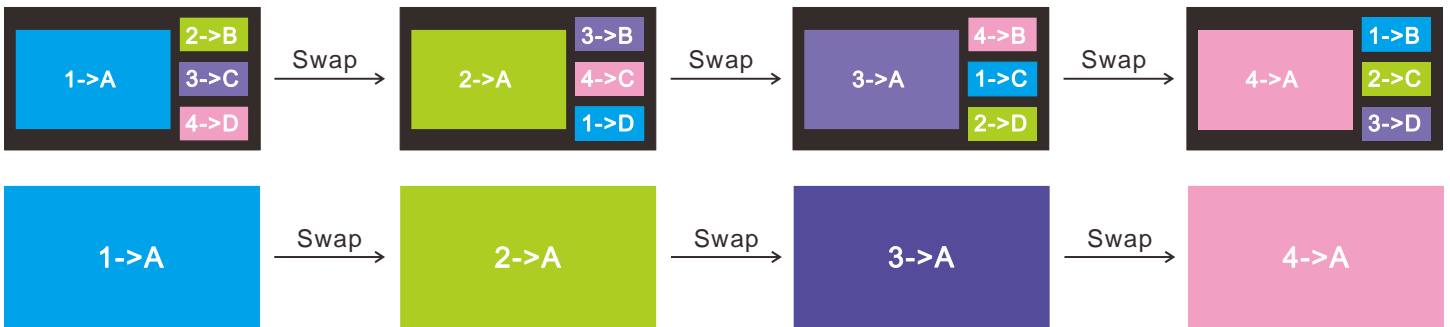

TekFlex-85T Pro

79285 User Manual

5.2.2 User-Defined Multiview Mode

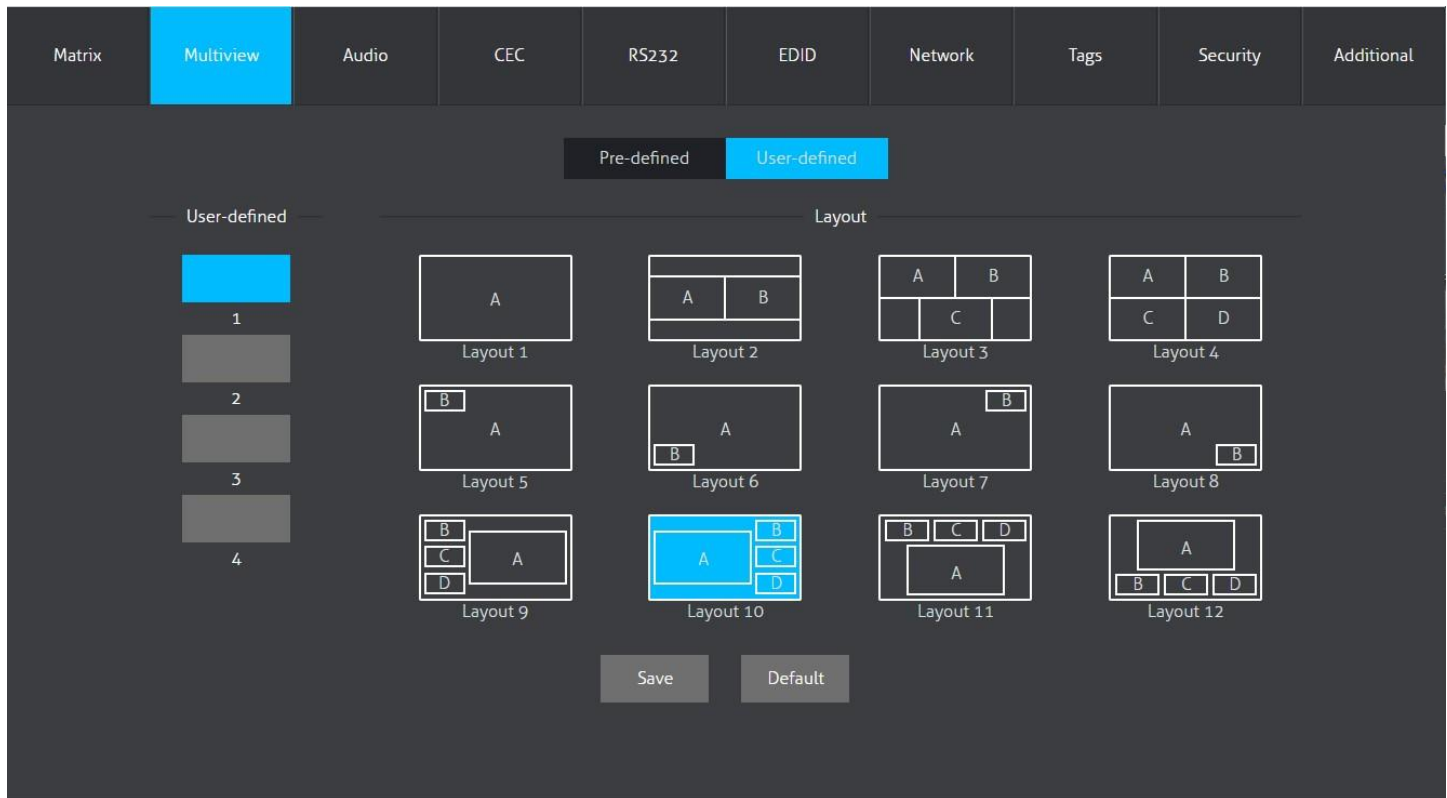

User-Defined: Select a user-defined layout number 1~4 to modify

Layout: Select the multiview layout to use for the selected user-defined layout number

Save: Set the selected user-defined layout number to the selected multiview layout

Default: Set the selected user-defined layout number to its default

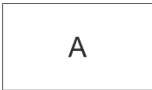
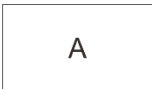
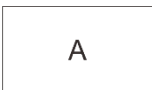
User-Defined Layout Number	Default Layout
1	
2	
3	
4	

Note: The User-Defined Multiview Modes can be invoked by pressing the “User 1 ~ User 4” buttons on the IR remote.

TekFlex-85T Pro

79285 User Manual

5.3 Audio Tab

5.3.1 Input Tab

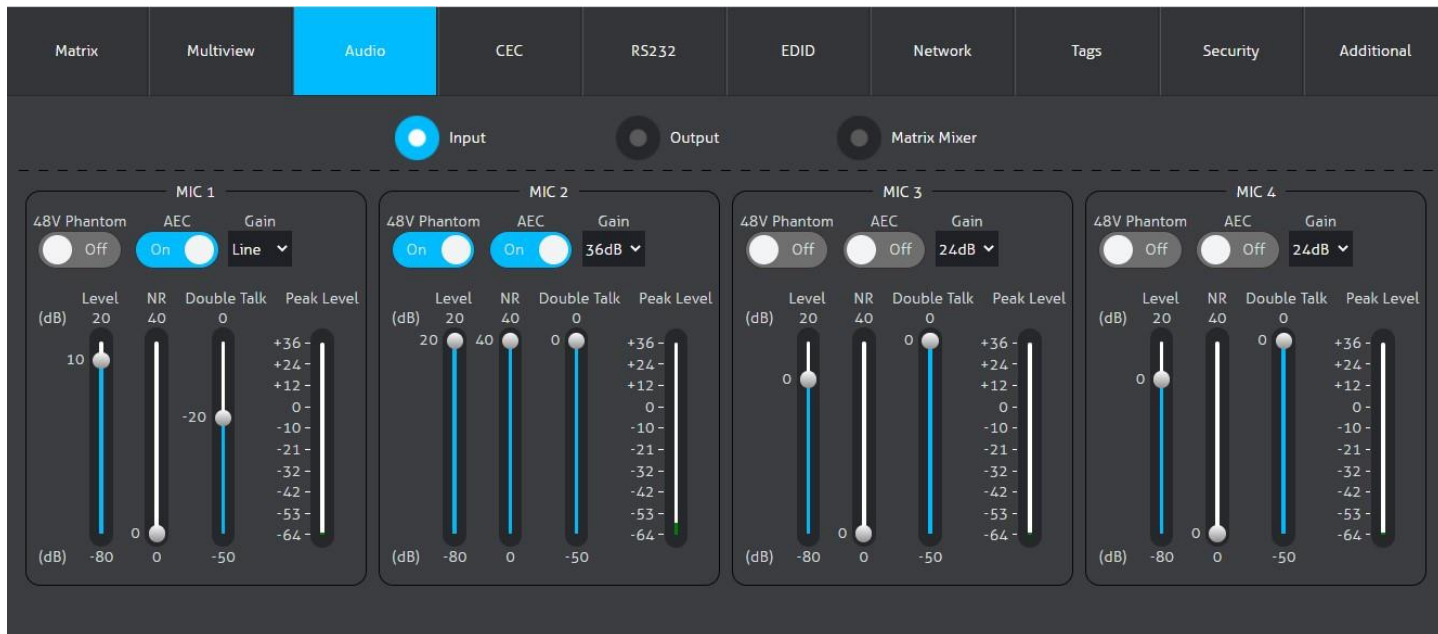

48V Phantom: Click to toggle 48V phantom power to the corresponding Mic audio input

AEC: Click to toggle Acoustic Echo Cancellation (AEC) on the corresponding Mic audio input

Gain: Set the Mic audio input's gain level (**Line, 6dB, 12dB, 18dB, 24dB, 30dB, 36dB, or 42dB**)

Level: Adjust the Mic audio input's level (**-80dB ~ 20dB**)

NR: Adjust how aggressive the Mic audio input's noise reduction should be (**0 ~ 40**)

Double Talk: Adjust how aggressive the Mic audio input's double-talk cancellation should be (**-50~0**)

Peak Level: Shows a real-time indicator of incoming volume on the corresponding Mic audio input

TekFlex-85T Pro

79285 User Manual

5.3.2 Output Tab



Speech Mix 5EQ: Use the sliders to adjust gain for different frequency ranges of the Speech audio channel to equalize microphone pickup volume

Output Levels:

- Use the sliders to adjust the volume of the corresponding audio output channel
- Press the Mute button under each slider to mute or un-mute the corresponding audio output channel

Audio Embedded:

- **4. HDBT Out:** Click to select whether the mixed Source & Speech audio or the selected source audio is embedded in the HDBaseT Output 4 signal
- **Multiview Audio:** Click to toggle whether the mixed Source & Speech audio is embedded in the HDMI Output 3 signal

TekFlex-85T Pro

79285 User Manual

5.3.3 Matrix Mixer Tab

Input		Speech	Far-End
MIC 1	Level(-60~0dB)	0	0
Mute	Connect	<input checked="" type="checkbox"/>	<input checked="" type="checkbox"/>
MIC 2	Level(-60~0dB)	0	0
Mute	Connect	<input checked="" type="checkbox"/>	<input checked="" type="checkbox"/>
MIC 3	Level(-60~0dB)	0	-60
Mute	Connect	<input checked="" type="checkbox"/>	<input type="checkbox"/>
MIC 4	Level(-60~0dB)	0	-60
Mute	Connect	<input checked="" type="checkbox"/>	<input type="checkbox"/>

Mute: Press “Mute” next to each Mic audio input to mute it; if the “Mute” button is green, that input is active, if the button is red that input is currently muted

Connect: Next to “Connect” for each Mic audio input, choose whether that input is connected to the Speech channel and/or the Far-End; a blue bar indicates an active connection.

Level: For each Mic audio input, enter the level of that input (-60dB ~ 0dB) sent to each output channel

TekFlex-85T Pro

79285 User Manual

5.4 CEC Tab

5.4.1 Source Control

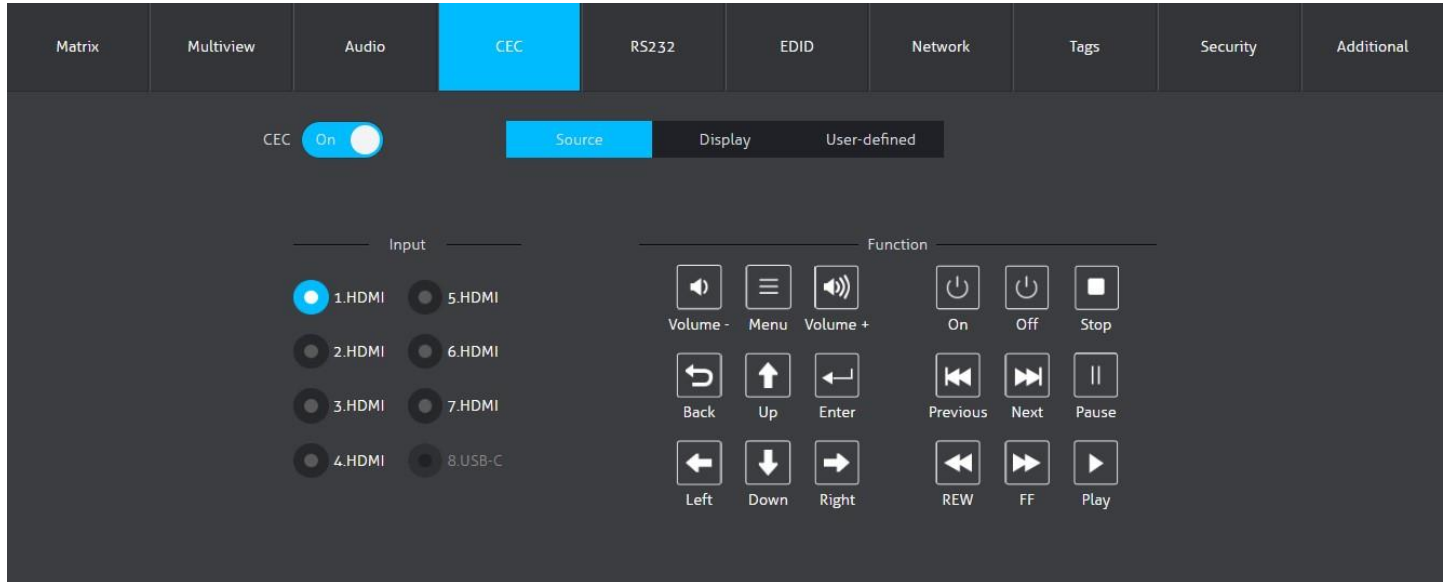

Select the HDMI input source to be controlled, then click the desired function button(s)

5.4.2 Display Control

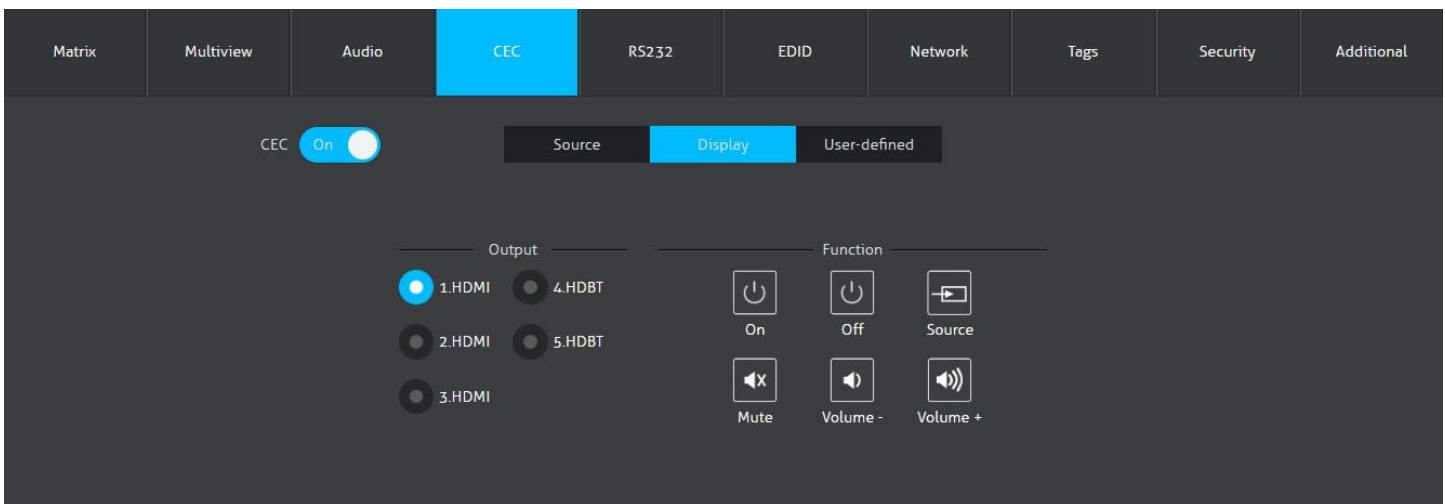

Select the output display device to be controlled, then click the desired function button(s)

TekFlex-85T Pro

79285 User Manual

5.4.3 User-Defined Control

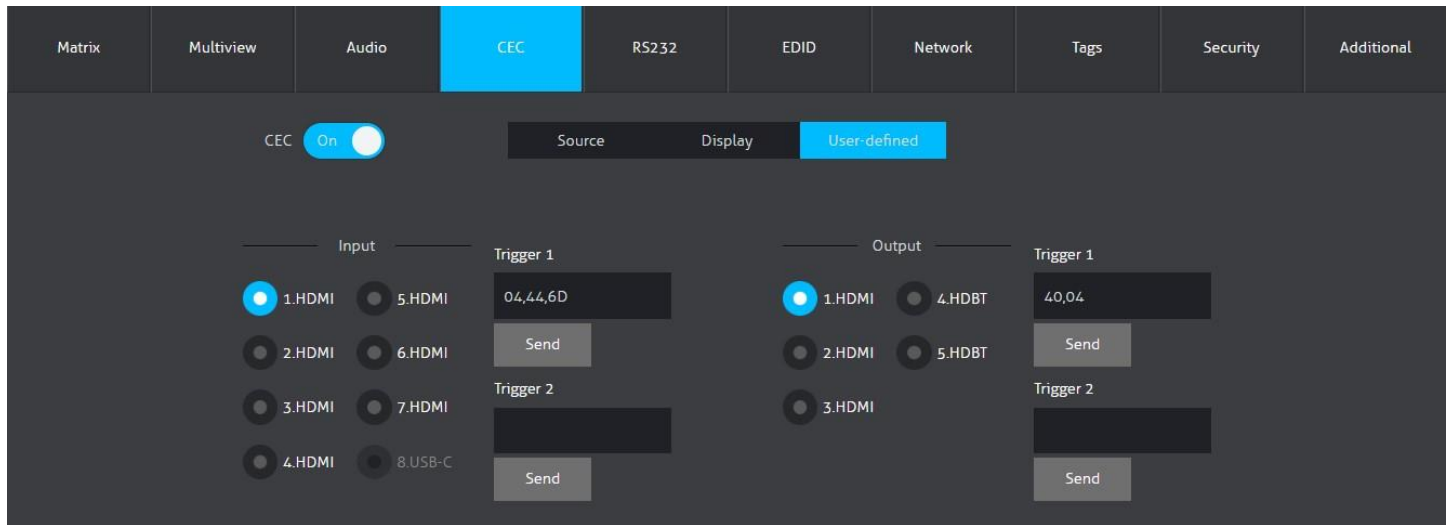

Select an HDMI input source or output display device, then type the desired CEC command in the appropriate "Trigger 1" or "Trigger 2" field and click "Send" to send that command to control the selected device.²

Playback Device	
Pause	04,44,46
Play	04,44,44
Stop	04,44,45
PwrOn	04,44,6D
PwrOff	04,44,6C

Display	
PowerOn	40,04
PowerOff	F0,36 / 40,36
Volume Up	40,44,41
Volume Down	40,44,42
Mute	04,44,43

- | Address Device list | |
|---------------------|-------------------------------------|
| 0 | TV |
| 1 | Recording Device 1 |
| 2 | Recording Device 2 |
| 3 | Tuner 1 |
| 4 | Playback Device 1 |
| 5 | Audio System |
| 6 | Tuner 2 |
| 7 | Tuner 3 |
| 8 | Playback Device 2 |
| 9 | Recording Device 3 |
| A | Tuner 4 |
| B | Playback Device 3 |
| C | Reserved |
| D | Reserved |
| E | Specific Use |
| F | Unregistered (as Initiator address) |
| | Broadcast (as Destination address) |

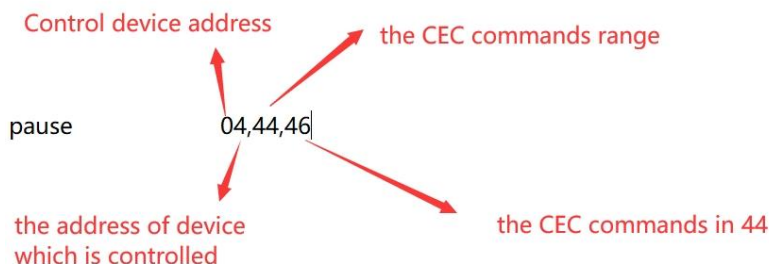

² **Note:** The CEC standard is primarily formulated by TV manufacturers, and is generally compatible with TVs and Blu-ray Players and may not be compatible with the source devices of other manufacturers, such as, Apple TV, etc.

TekFlex-85T Pro

79285 User Manual

5.5 RS232 Tab

Matrix Multiview Audio CEC **RS232** EDID Network Tags Security Additional

Local 4. HDBT Out 5. HDBT Out

HEX ASCII

Baud Rate: 9600

Command Ending: CR

Command: PWR ON

Confirm Cancel

Local / 4. HDBT Out / 5. HDBT Out: Select an RS232 port of the matrix switcher

HEX / ASCII: Select whether to send commands in hexadecimal or ASCII format

Baud Rate: Select baud rate for sent commands (**115200, 57600, 38400, 19200, 9600**; default **9600**)

Command Ending: Choose which, if any, special characters to send at end of RS232 commands (**NULL, CR, LF, or CR+LF**)

Command: Type a command to send via the selected RS232 port to control a third-party device, then press "Confirm" to send

TekFlex-85T Pro

79285 User Manual

5.6 EDID Tab

5.6.1 EDID Copy

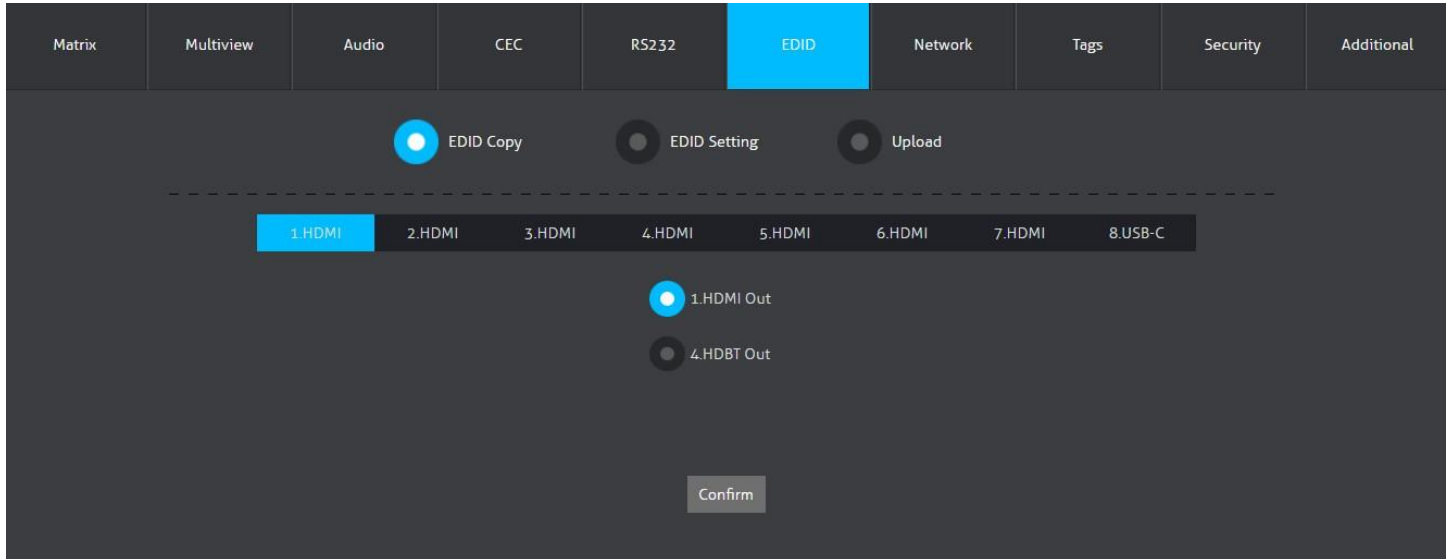

Select an input source, then choose an output EDID to copy to that input and press “Confirm” to apply changes

5.6.2 EDID Setting

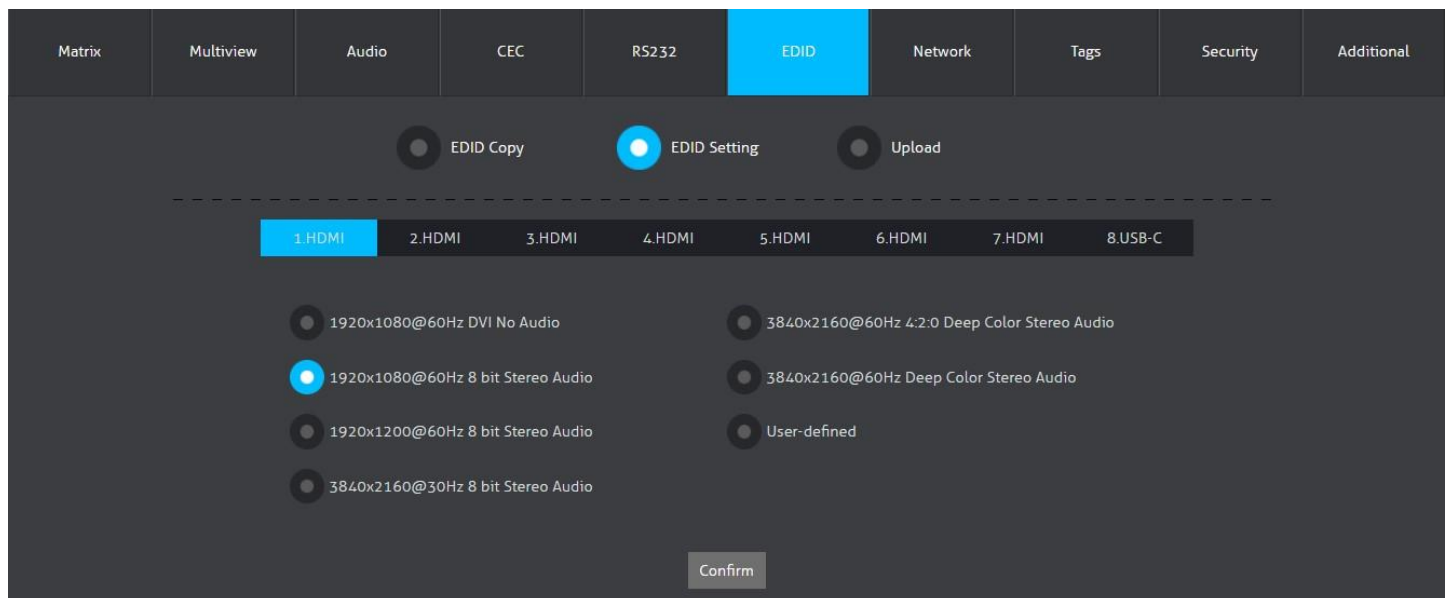

Select an input source, then select an EDID resolution to apply to that input and press “Confirm”

TekFlex-85T Pro

79285 User Manual

5.6.3 EDID Upload

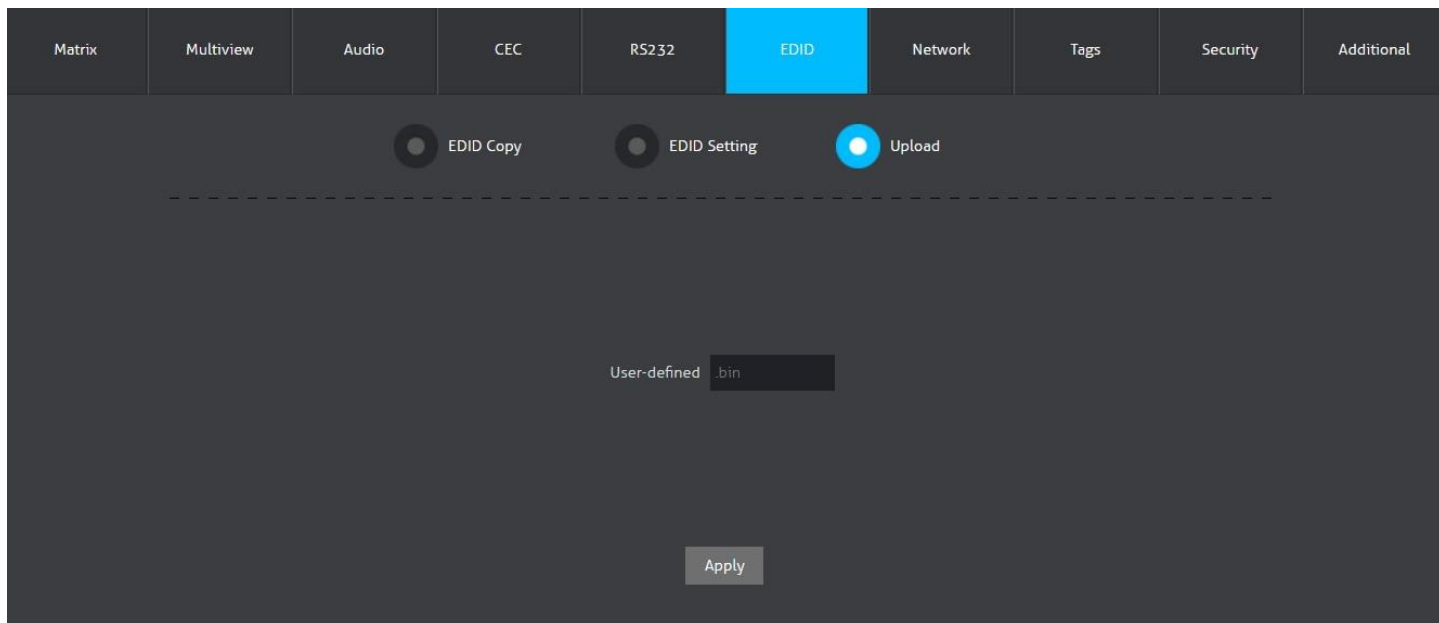

Prepare the EDID file (.bin) on the PC being used to access the web GUI, then click the user-defined box and navigate to the EDID file in the PC's file system. Click "Apply" to upload the EDID file.

5.7 Network Tab

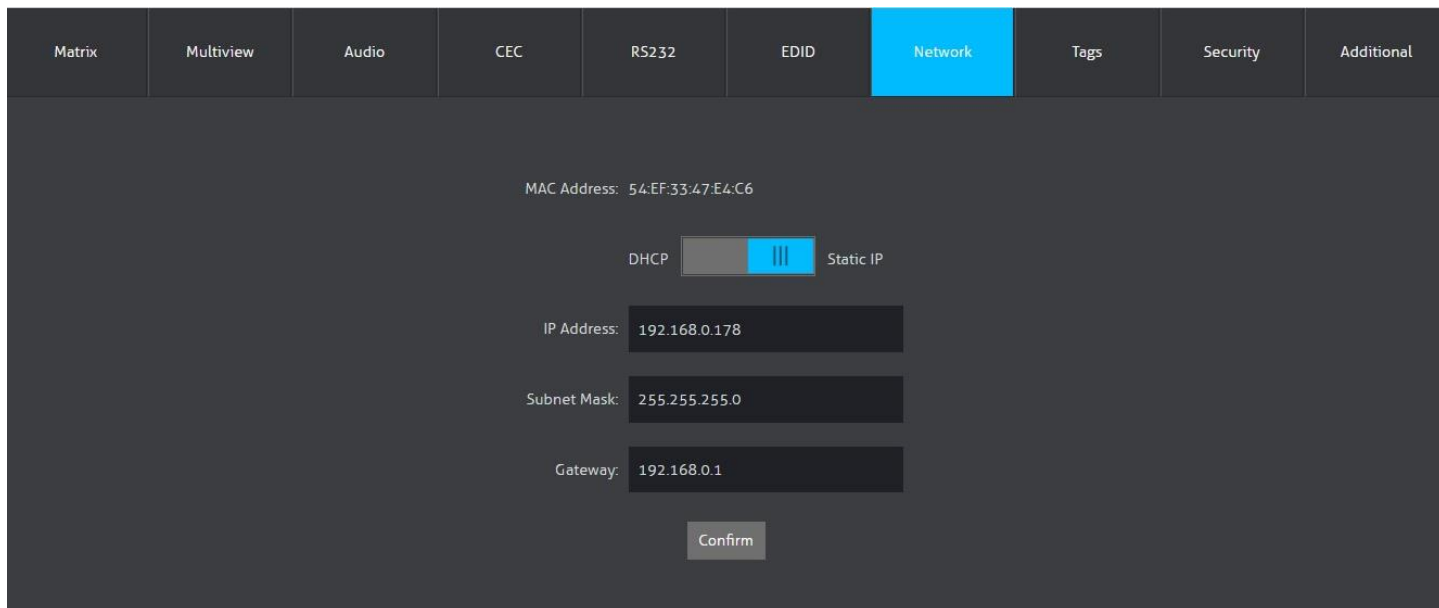

Select the matrix switcher to "**DHCP**" (Dynamic Host Configuration Protocol) or "**Static IP**"
Set the **IP Address**, **Subnet Mask**, and **Gateway** (only available when set to Static IP)

TekFlex-85T Pro

79285 User Manual

5.8 Tags Tab

5.8.1 Input & Output Tags

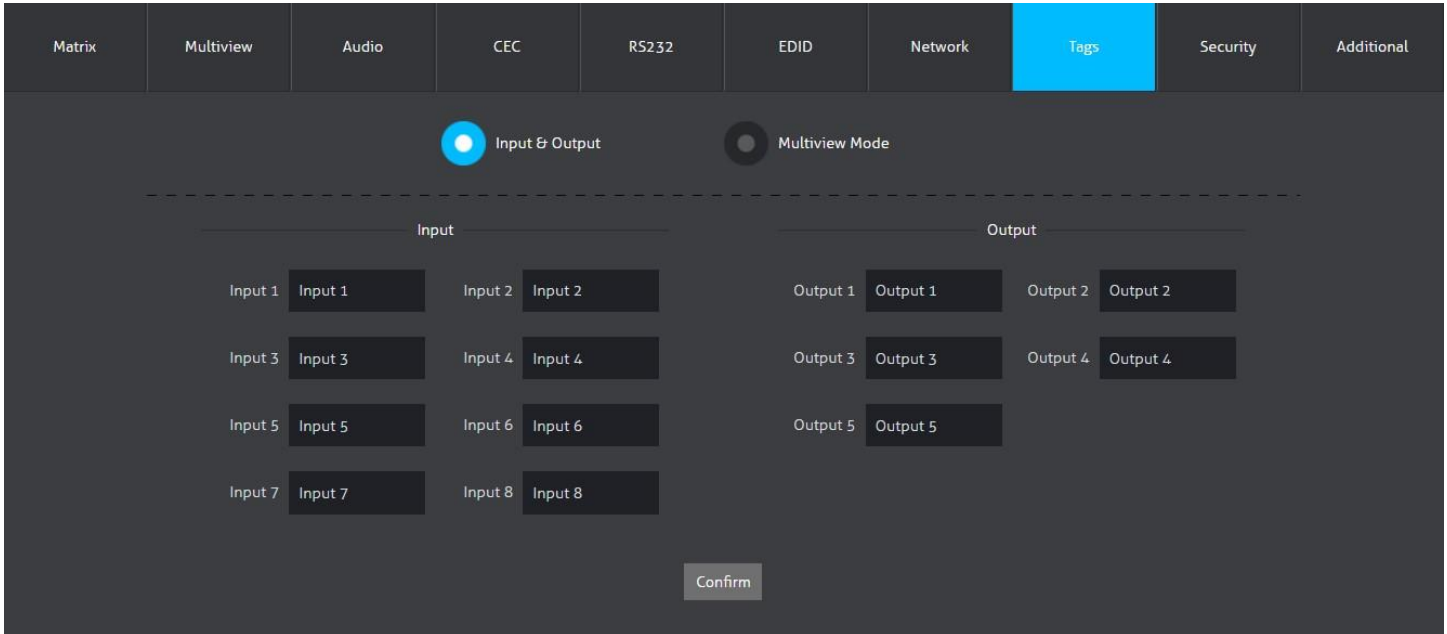

Set custom labels for each of the inputs and outputs, as desired

5.8.2 Multiview Mode Tags

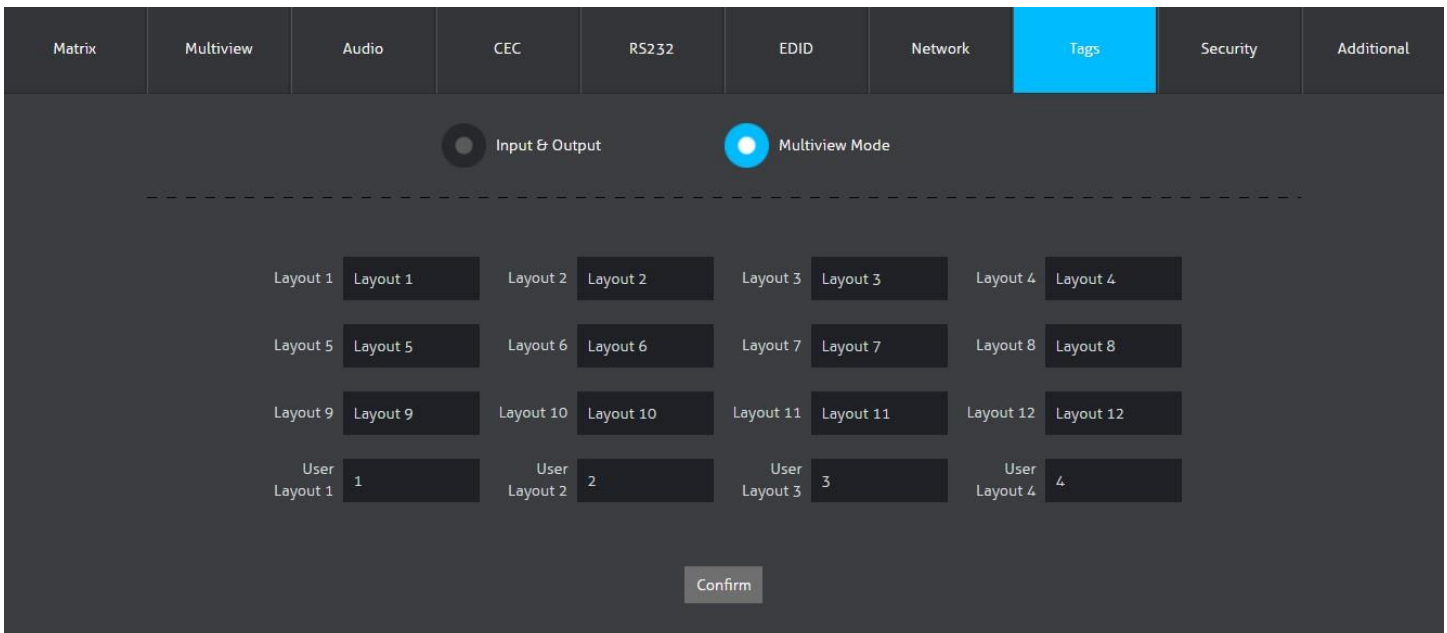

Set custom labels for each of the 12 pre-defined multiview layouts, as well as the 4 user-defined multiview layouts

TekFlex-85T Pro

79285 User Manual

5.9 Security Tab

The screenshot displays the Security Tab interface. At the top, a navigation bar contains tabs for Matrix, Multiview, Audio, CEC, RS232, EDID, Network, Tags, Security (active), and Additional. The main content area is divided into four sections:

- Password:** A text input field contains the text "admin", followed by a "Confirm" button.
- Firmware Upgrade:** A dark grey button is present, followed by a "Confirm" button.
- Factory Default:** A single grey square button.
- Front Panel Lock:** A toggle switch with "ON" on the left and "OFF" on the right. The switch is currently in the "OFF" position.

Password: Modify web GUI login password; press “Confirm” to apply changes

Firmware Upgrade: Click the box and navigate to the firmware upgrade file on the PC being used to access the web GUI, then click “Confirm” to begin the firmware update

Factory Default: Click to restore matrix switcher to its factory default settings

Front Panel Lock: When this setting is enabled, the buttons on the front panel of the switcher cannot be used to control the matrix switcher

TekFlex-85T Pro

79285 User Manual

5.10 Additional Tab

5.10.1 Additional Settings

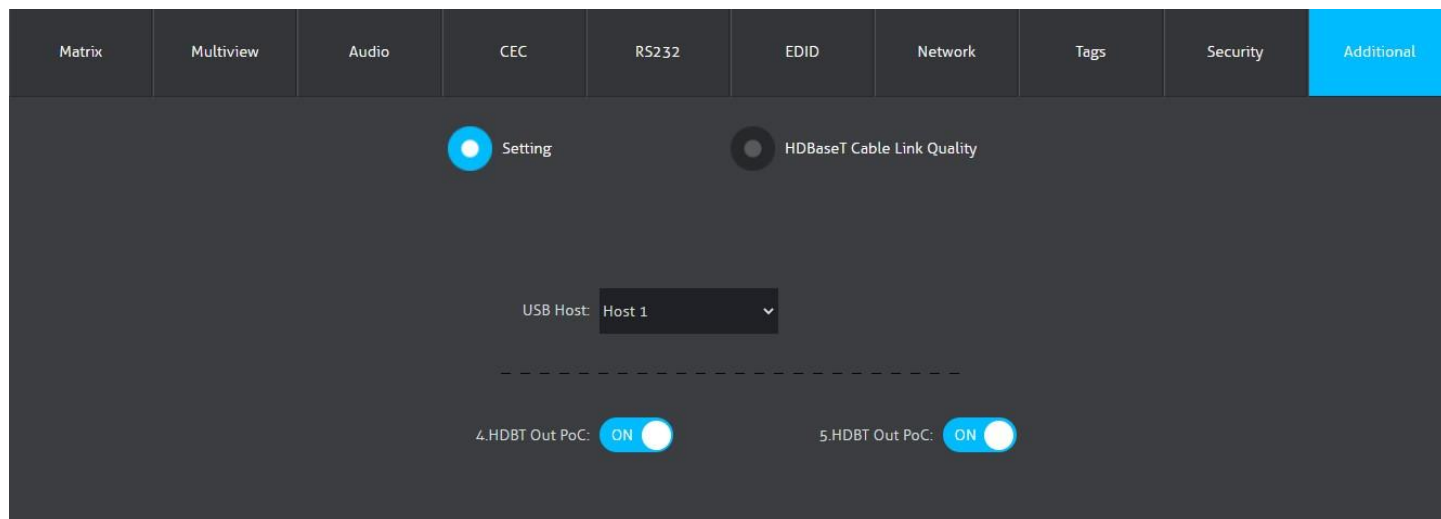

USB Host: Select which USB host all connected USB devices should be routed to (**Host 1, Host 2, Host 3, USB-C, HDBT4-RX1, HDBT5-RX2, or Auto**)

HDBT PoC: Toggle whether the matrix switcher is supplying PoC power via each of its HDBase outputs

5.10.2 HDBaseT Cable Link Quality

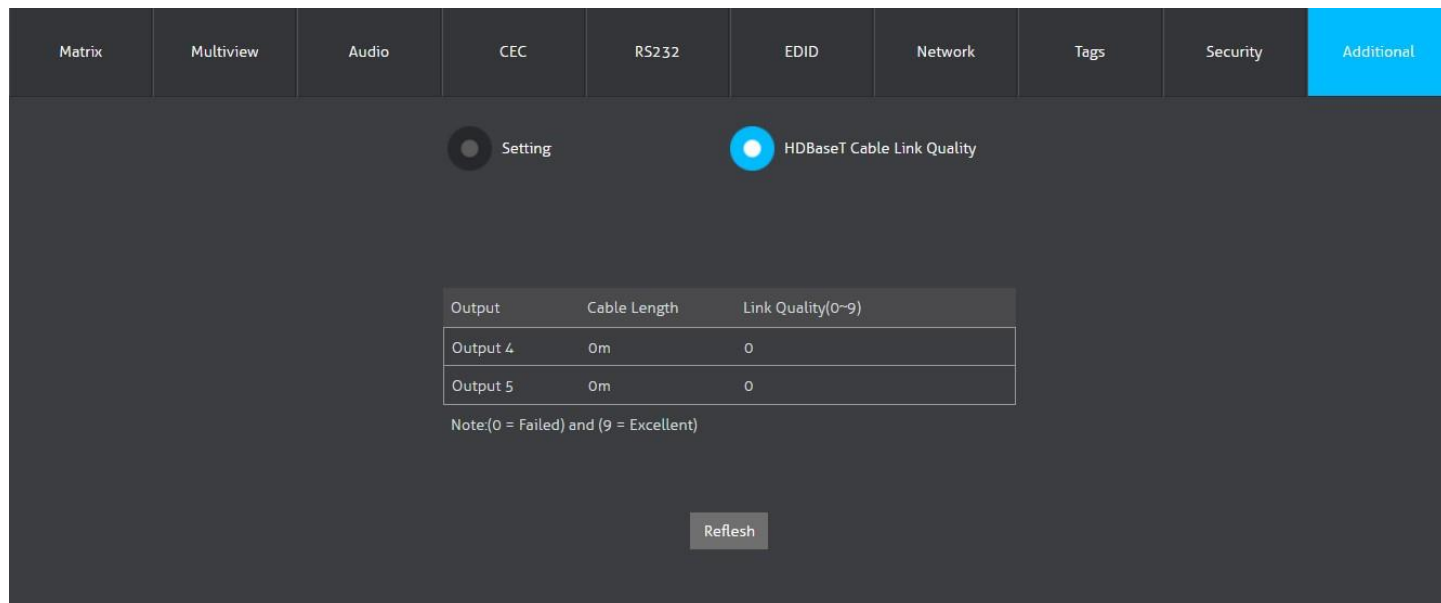



Displays approximate length and connection quality for each cable connected to the matrix switcher's HDBaseT outputs

TekFlex-85T Pro

79285 User Manual

6. IR Remote Control

- The matrix switcher includes an IR EYE port for connecting an IR receiver, and can be controlled by the IR remote as described below.³

- Inputs:** 8 buttons for input source selection
- Outputs:** 5 buttons for output selection
- Menu:**
 - EDID:** To set the EDID for one or more source devices, press “EDID”, then the desired Input numbers (or “ALL”), then the Output number of the desired display, then press “ENTER” to confirm
 - CLEAR:** Press to cancel any operation before the “ENTER” button has been pressed
- Volume:**
 - MIC:** Press and hold for at least 3 seconds to switch between controlling Source and Speech audio channels
 - Mute:** Press to mute selected audio channel
 - & +:** Press to decrease or increase volume of selected audio channel, respectively
- Multiview:**
 - Windows A~D:** 4 buttons for multiview output window selection
 -  Cycle through the video sources displayed in each window
 -  Adjust multiview window size
 -  Change output resolution
 - User 1~4:** 4 buttons for User-Defined Multiview Mode selection
 - 4 bottom buttons are for Pre-Defined Multiview Mode selection

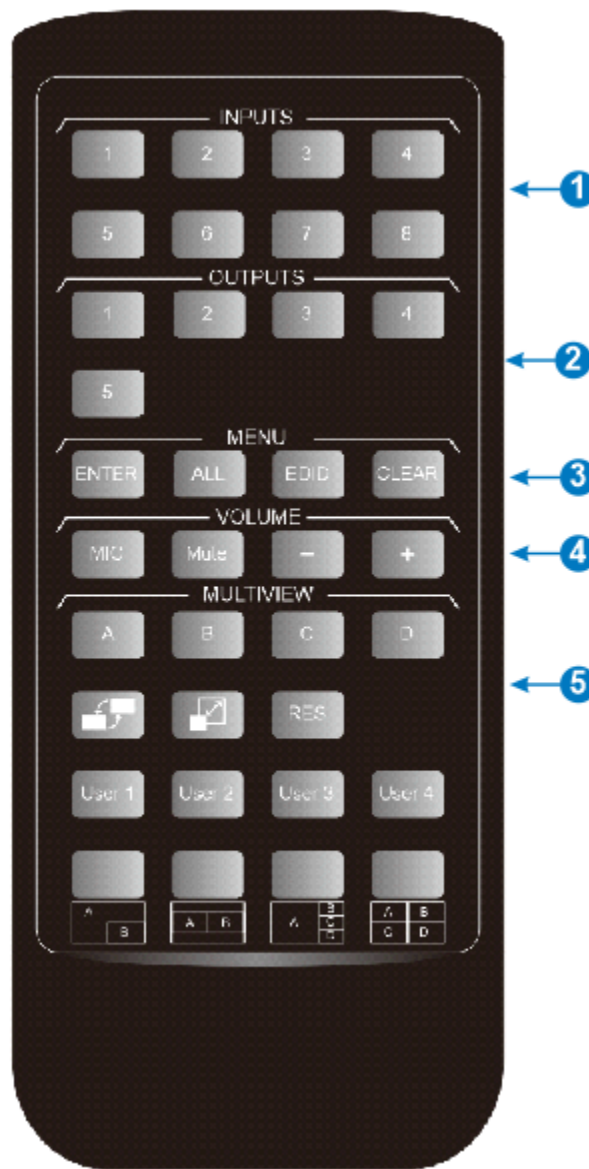

³ Note: All IR Remote functions work identically to the web GUI controls. Please refer to §5. GUI Control for more details

TekFlex-85T Pro

79285 User Manual

7. RS232 Control

The RS232 port of the matrix switcher has two control methods:

- **Local Control:** Connect the switcher's RS232 port to a control device to control the switcher via RS232 commands
- **Remote Display Control:** Connect one or more of the switcher's RS232 passthrough ports to a controller to use a far-end HDBaseT receiver to control a display device

RS232 Commands:

The following command lists are used to control the matrix switcher. If using a PC, it must have RS232 control software installed in order to send RS232 commands.

After installing the RS232 control software, set the COM port, baud rate, data bit, stop bit, and parity bit correctly. Once this is done, RS232 commands can now be sent to the matrix switcher.

Baud Rate: 9600

Data Bit: 8

Stop Bit: 1

Parity Bit: None

Notes:

1. All commands need to be terminated with "<CR>"
2. All feedbacks are terminated with "<CR><LF>"
3. In the commands, "[" and "]" MUST be typed in actual operation
4. Type commands carefully, as they are case-sensitive
5. These same commands are used with TCP/IP port 4001

TekFlex-85T Pro

79285 User Manual

7.1 Audio and Video Switching

Command	Description	Command Example & Feedback
510y0x	Send video input to output y = Output number y = 1 ~ 2, 4 ~ 5 (Output number) or A ~ D (Multiview Window) x = Input source number x = 0 ~ 8; 0 = Off	51010x (x = 0 ~ 8) 51020x 51040x 51050x 510A0x 510B0x 510C0x 510D0x
510G00	Get video output	51010x (x = 0 ~ 8) 51020x 51040x 51050x 510A0x 510B0x 510C0x 510D0x
511y0x	Set audio output y = Output number (y = 1 ~ 3) 1 : Main 2 : Far-End 3 : AEC Ref x = Input source number x = 0 ~ 8; 0 = Off x = 9: Source Volume (AEC Ref ONLY)	51110x (x = 0 ~ 8) 51120x 51130x (x = 0 ~ 9)
511G00	Get audio output	51110x (x = 0 ~ 8) 51120x 51130x (x = 0 ~ 9)

TekFlex-85T Pro

79285 User Manual

7.2 Audio Settings

Command	Description	Command Example & Feedback
512y0x	Set Phantom power for inputs y = Mic input number (y = 1 ~ 4) x = 0 ~ 1 0 : Off 1 : On	51210x (x = 1/0 On/Off) 51220x 51230x 51240x
512G00	Get Phantom power status	51210x (x = 1/0 On/Off) 51220x 51230x 51240x
513y0x	Set AEC for MIC inputs y = Mic input number (y = 1 ~ 4) x = 0 ~ 1 0 : Off 1 : On	51310x (x = 1/0 On/Off) 51320x 51330x 51340x
513G00	Get AEC status	51310x (x = 1/0 On/Off) 51320x 51330x 51340x
514y0x	Set gain for MIC inputs y = Mic input number (y = 1 ~ 4) x = Gain (x = 0 ~ 7) 0 : Line 1 : 6dB 2 : 12dB 3 : 18dB 4 : 24dB 5 : 30dB 6 : 36dB 7 : 42dB	51410x (x = 0 ~ 7) 51420x 51430x 51440x

TekFlex-85T Pro

79285 User Manual

Command	Description	Command Example & Feedback
514G00	Get MIC gain	51410x (x = 0 ~ 7) 51420x 51430x 51440x
515yxx	Set MIC level y = Mic input number (y = 1 ~ 4) xx = Mic level (xx = 0 ~ 60)	5151xx (xx = 0 ~ 60) 5152xx 5153xx 5154xx
515y0x	Set Mix mute y = Mic input number (y = 5 ~ 8) 5: MIC 1 6: MIC 2 7: MIC 3 8: MIC 4 x = 0 ~ 1 0: Mute Off 1: Mute On	51550x (x = 0/1) 51560x 51570x 51580x
515G00	Get Mic Level and Mute	5151xx (xx = 0 ~ 60) 5152xx 5153xx 5154xx 51550x (x = 0/1) 51560x 51570x 51580x
516yxx	Set Mic Noise Reduction (NR) y = Mic input number (y = 1 ~ 4) xx = 00 ~ 40 00: 0 40: -40	5161xx (xx = 00 ~ 40) 5162xx 5163xx 5164xx
516G00	Get Mic NR	5161xx (xx = 00 ~ 40) 5162xx 5163xx 5164xx

TekFlex-85T Pro

79285 User Manual

Command	Description	Command Example & Feedback
517yxx	Set AEC Double-Talk Cancellation y = Mic input number (y = 1 ~ 4) xx = 00 ~ 50 00 : -50 50 : 0	5171xx (xx = 00 ~ 50) 5172xx 5173xx 5174xx
517G00	Get AEC Double-Talk setting	5171xx (xx = 00 ~ 50) 5172xx 5173xx 5174xx
518yxx	Set Mic EQ levels y = EQ Band number (y = 1 ~ 5) xx = 00 ~ 24 00 : -12 12 : 0 24 : 12	5181xx (xx = 00 ~ 24) 5182xx 5183xx 5184xx 5185xx
518G00	Get Mic EQ	5181xx (xx = 00 ~ 24) 5182xx 5183xx 5184xx 5185xx
519yxx	Set audio output level y = Audio output (y = 1 ~ 4) 1 : Source 2 : Speech 3 : AEC Ref 4 : Far-End xx = Output level (xx = 00 ~ 60) 00 : -60dB 60 : 0dB	5191xx (xx = 00 ~ 60) 5192xx 5193xx 5194xx

TekFlex-85T Pro

79285 User Manual

Command	Description	Command Example & Feedback
519y0x	<p>Set audio output mute</p> <p>y = Audio output (y = 5 ~ 8) 5: Source 6: Speech 7: AEC Ref 8: Far-End</p> <p>x = Audio mute (x = 0 ~ 1) 0: Mute Off 1: Mute On</p>	<p>51950x (x = 0/1) 51960x 51970x 51980x</p>
519G00	<p>Get audio output level and mute</p>	<p>5191xx (xx = 00 ~ 60) 5192xx 5193xx 5194xx 51950x (x = 0/1) 51960x 51970x 51980x</p>
520yxx	<p>Set Crosspoint Speech level</p> <p>y = Mic input number (y = 1 ~ 4)</p> <p>xx = 00 ~ 60 00: -60dB 60: 0dB</p>	<p>5201xx (xx = 00 ~ 60) 5202xx 5203xx 5204xx</p>
520y0x	<p>Set Crosspoint Speech Connect</p> <p>y = Mic input number (y = 5 ~ 8) 5: MIC 1 6: MIC 2 7: MIC 3 8: MIC 4</p> <p>x = 0 ~ 1 0: Not Connected 1: Connected</p>	<p>52050x (x = 0/1 Off/On) 52060x 52070x 52080x</p>

TekFlex-85T Pro

79285 User Manual

Command	Description	Command Example & Feedback
520G00	Get Speech Crosspoint level and connection status	5201xx (xx = 0 ~ 60) 5202xx 5203xx 5204xx 52050x (x = 0/1 Off/On) 52060x 52070x 52080x
521yxx	Set Crosspoint Far-End Level y = Mic input number (y = 1 ~ 4) xx = 00 ~ 60 00 : -60dB 60 : 0dB	5211xx (xx = 0 ~ 60) 5212xx 5213xx 5214xx
521y0x	Set Crosspoint Speech Connect y = Mic input number (y = 5 ~ 8) 5 : MIC 1 6 : MIC 2 7 : MIC 3 8 : MIC 4 x = 0 ~ 1 0 : Not Connected 1 : Connected	52150x (x = 0 / 1 Off / On) 52160x 52170x 52180x
521G00	Get Far-End Crosspoint level and connections tatus	5211xx (xx = 0 ~ 60) 5212xx 5213xx 5214xx 52150x (x = 0/1 Off / On) 52160x 52170x 52180x
52200x	HDBaseT Embedded Audio x = 0 / 1 0 : Off 1 : On	52200x (x = 0 / 1)

TekFlex-85T Pro

79285 User Manual

Command	Description	Command Example & Feedback
522G00	Get HDBaseT Embedded Audio Status	52200x (x = 0 / 1)
52201x	Multiview Embedded Audio x = 0 / 1 0: Off 1: On	52201x (x = 0 / 1)
522G01	Get Multiview Embedded Audio Status	52201x (x = 0 / 1)

7.3 Function Settings

Command	Description	Command Example & Feedback
523y0x	Set Output HDCP Mode y = Output number (y = 1~2, 4~5) x = 0 ~ 2 0: Off 1: Force HDCP 1.4 2: HDCP 2.2	52310x (x = 0 ~ 2) 52320x 52340x 52350x
523G00	Get Output HDCP Mode	52310x (x = 0 ~ 2) 52320x 52340x 52350x

TekFlex-85T Pro

79285 User Manual

Command	Description	Command Example & Feedback
524y0x	Set Input EDID y = Input number (y = 1 ~ 8) x = 0 ~ 8 0: From HDMI Out 1 Display 1: 1920x1080@60Hz DVI No Audio 2: 1920x1080@60Hz 8 bit Stereo Audio 3: 1920x1200@60Hz 8 bit Stereo Audio 4: 3840x2160@30Hz 8 bit Stereo Audio 5: 3840x2160@60Hz 4:2:0 Deep Color Stereo Audio 6: 3840x2160@60Hz Deep Color Stereo Audio 7: From HDBT Out 4 Display 8: USER	52410x (x = 0 ~ 8) 52420x 52430x 52440x 52450x 52460x 52470x 52480x
524G00	Get Input EDID	52410x (x = 0 ~ 8) 52420x 52430x 52440x 52450x 52460x 52470x 52480x
52202S	Set User EDID	<User edid ready,Please send edid data in 10s. 522020 (False) 522021 (True)
52203x	Set CEC x = 0 / 1 0 : Off 1 : On	522030 (Off) 522031 (On)
522G03	Get CEC Status	522030 (Off) 522031 (On)

TekFlex-85T Pro

79285 User Manual

Command	Description	Command Example & Feedback
52204x	Set Front Panel Lock x = 0 / 1 0: Unlock 1: Lock	522040 (Unlocked) 522041 (Locked)
522G04	Get Front Panel Lock Status	522040 (Unlocked) 522041 (Locked)
52205x	Set Standby Mode x = 0 / 1 0: Standby Off 1: Standby On	522050 (Standby Off) 522051 (Standby On)
522G05	Get Standby Mode Status	522050 (Standby Off) 522051 (Standby On)
522G06	Get System Status	(Standby) (Video Outputs) (Audio Outs) (Output Levels) (Output Mutes) (Mic Levels) (Audio Matrix Speech Level) (Audio Matrix Far Level) (Phantom Power) (AEC On/Off) (Mic Gain) (Mic NR) (AEC DoubleTalk) (Mic EQ) (HDBT Embedded Audio) (MV Far-End Embedded Audio) (CEC Off/On) (HDBT POC) (Resolution) (EDID) (Front Lock) (Multiview Mode) (USB Mode) (Freeze Window A)

TekFlex-85T Pro

79285 User Manual

Command	Description	Command Example & Feedback
525y0x	Set HDBaseT PoC y = HDBT Output (y = 1 ~ 2) x = 0 ~ 1 0: Off 1: On	52510x (x = 0/1 Off / On) 52520x
525G00	Get HDBaseT PoC Status	52510x (x = 0/1 Off / On) 52520x
52210x	Set USB Mode x = 1 ~ 7 1: Auto switch <i>Auto (In 1 = USB 1, In 3 = USB 2, In 4 = USB 3, In 8 = USB C)</i> Auto will be linked to the Input selected to Output 1 2: USB-C 3: Host1 4: Host2 5: Host3 6: HDBT4-RX1 7: HDBT5-RX2	52210x (x = 1 ~ 7)
522G10	Get USB Mode	52210x (x = 1 ~ 7)
52211x	Set Preset (x = 1 ~ 6)	52211x (x = 1 ~ 6)
522G11	Get Preset	52211x (x = 1 ~ 6)
52212x	Recall Preset (x = 1 ~ 6)	51010y (y = 0 ~ 2, 4 ~ 5, A ~ D) 51020y 51040y 51050y 510A0y 510B0y 510C0y 510D0y

TekFlex-85T Pro

79285 User Manual

Command	Description	Command Example & Feedback
526y0x	Set HDBT Control y = HDBT Output (y = 1 ~ 2) x = 0 ~ 1 0 : Off 1 : On	526100 / 526101 526200 / 526201
526G00	Get HDBT Control status	526100 / 526101 526200 / 526201

7.4 Window Settings

Command	Description	Command Example & Feedback
52213x	Set Output Resolution (x = 1 ~ 7) 1 : 1360x768 60 2 : 1440x900 60 3 : 1920x1080 50 4 : 1920x1080 60 (Default) 5 : 3840x2160 30 6 : 3840x2160 50 7 : 3840x2160 60	52213x (x = 1 ~ 7)
522G13	Get Output Resolution	52213x (x = 1 ~ 7)
5281xx	Set the Multiview mode (xx = 01~12) 01 : 1 WINDOWS Full (Default) 02 : 2 WINDOWS PBP 03 : 3 WINDOWS 2U1D 04 : 4 WINDOWS SAME SIZE 05 : 2 WINDOWS PIP LU 06 : 2 WINDOWS PIP LD 07 : 2 WINDOWS PIP RU 08 : 2 WINDOWS PIP RD 09 : 4 WINDOWS PBP 3L1R 10 : 4 WINDOWS PBP 1L3R 11 : 4 WINDOWS PBP 3U1D 12 : 4 WINDOWS PBP 1U3D	5281xx (xx = 01 ~ 12)
528G00	Get the Multiview mode	5281xx (xx = 01 ~ 12)

TekFlex-85T Pro

79285 User Manual

Command	Description	Command Example & Feedback
529yxx	Set the User-Defined Multiview Mode y = User number (y = 1 ~ 4) xx = 01 ~ 12 01: 1 WINDOWS Full (Default) 02: 2 WINDOWS PBP 03: 3 WINDOWS 2U1D 04: 4 WINDOWS SAME SIZE 05: 2 WINDOWS PIP LU 06: 2 WINDOWS PIP LD 07: 2 WINDOWS PIP RU 08: 2 WINDOWS PIP RD 09: 4 WINDOWS PBP 3L1R 10: 4 WINDOWS PBP 1L3R 11: 4 WINDOWS PBP 3U1D 12: 4 WINDOWS PBP 1U3D	5291xx (xx = 01 ~ 12) 5292xx (xx = 01 ~ 12) 5293xx (xx = 01 ~ 12) 5294xx (xx = 01 ~ 12)
529G01	Get the user-defined Multiview mode for User 1	5291xx (xx = 01 ~ 12)
529G02	Get the user-defined Multiview mode for User 2	5292xx (xx = 01 ~ 12)
529G03	Get the user-defined Multiview mode for User 3	5293xx (xx = 01 ~ 12)
529G04	Get the user-defined Multiview mode for User 4	5294xx (xx = 01 ~ 12)
522014	Swap input source of window A to D	Window A: 510A0x (x = 1 ~ 8) Window B: 510B0x Window C: 510C0x Window D: 510D0x
522015	Resize display windows	522015
5221yx	Freeze Multiview window y = Multiview window (y = 6 ~ 9) 6 : Window A 7 : Window B 8 : Window C 9 : Window D x = 0 / 1 0 : Freeze Off 1 : Freeze On	522160 / 522161 522170 / 522171 522180 / 522181 522190 / 522191

TekFlex-85T Pro

79285 User Manual

Command	Description	Command Example & Feedback
52220x	Freeze All Windows x = 0 / 1 0: Freeze Off 1: Freeze On	522160 / 522161 522170 / 522171 522180 / 522181 522190 / 522191
522G20	Get Freeze status	522160 / 522161 522170 / 522171 522180 / 522181 522190 / 522191

7.5 CEC Function Commands

Command	Description	Command Example & Feedback
52221x	CEC Source Menu x = HDMI input number (x = 1 ~ 7)	52221x (x = 1 ~ 7)
52222x	CEC Source Up x = HDMI input number (x = 1 ~ 7)	52222x (x = 1 ~ 7)
52223x	CEC Source Down x = HDMI input number (x = 1 ~ 7)	52223x (x = 1 ~ 7)
52224x	CEC Source Left x = HDMI input number (x = 1 ~ 7)	52224x (x = 1 ~ 7)
52225x	CEC Source Right x = HDMI input number (x = 1 ~ 7)	52225x (x = 1 ~ 7)
52226x	CEC Source Back x = HDMI input number (x = 1 ~ 7)	52226x (x = 1 ~ 7)
52227x	CEC Source Enter x = HDMI input number (x = 1 ~ 7)	52227x (x = 1 ~ 7)
52228x	CEC Source On x = HDMI input number (x = 1 ~ 7)	52228x (x = 1 ~ 7)

TekFlex-85T Pro

79285 User Manual

Command	Description	Command Example & Feedback
52229x	CEC Source Off x = HDMI input number (x = 1 ~ 7)	52229x (x = 1 ~ 7)
52230x	CEC Source Stop x = HDMI input number (x = 1 ~ 7)	52230x (x = 1 ~ 7)
52231x	CEC Source Play x = HDMI input number (x = 1 ~ 7)	52231x (x = 1 ~ 7)
52232x	CEC Source Pause x = HDMI input number (x = 1 ~ 7)	52232x (x = 1 ~ 7)
52233x	CEC Source Previous x = HDMI input number (x = 1 ~ 7)	52233x (x = 1 ~ 7)
52234x	CEC Source Next x = HDMI input number (x = 1 ~ 7)	52234x (x = 1 ~ 7)
52235x	CEC Source Rewind x = HDMI input number (x = 1 ~ 7)	52235x (x = 1 ~ 7)
52236x	CEC Source Fast Forward x = HDMI input number (x = 1 ~ 7)	52236x (x = 1 ~ 7)
52237x	CEC Source Mute x = HDMI input number (x = 1 ~ 7)	52237x (x = 1 ~ 7)
52238x	CEC Source Vol Up x = HDMI input number (x = 1 ~ 7)	52238x (x = 1 ~ 7)
52239x	CEC Source Vol Down x = HDMI input number (x = 1 ~ 7)	52239x (x = 1 ~ 7)

TekFlex-85T Pro

79285 User Manual

Command	Description	Command Example & Feedback
>CEC<xx1,xx2,xx3,xx....>	<p>Send a user-defined CEC command.</p> <p>xx1 = 1~ 12 1: In 1 2: In 2 3: In 3 4: In 4 5: In 5 6: In 6 7: In 7 8: Out 1 9: Out 2 10: Out 3 11: Out 4 12: Out 5</p> <p>xx2 = DEVICE ADDRESS xx3 = OPCODE xx... = COMMAND</p>	<p>>CEC<1,04,44,46>\</p> <p><CEC send to device:1 Header: 0x04 Opcode: 0x44 Message: 0x46</p>
52246x	<p>CEC Display On</p> <p>x = Output number (x = 1 ~ 5)</p>	52246x (x = 1 ~ 5)
52247x	<p>CEC Display Off</p> <p>x = Output number (x = 1 ~ 5)</p>	52247x (x = 1 ~ 5)
52248x	<p>CEC Display Source</p> <p>x = Output number (x = 1 ~ 5)</p>	52248x (x = 1 ~ 5)
52249x	<p>CEC Display Mute</p> <p>x = Output number (x = 1 ~ 5)</p>	52249x (x = 1 ~ 5)
52250x	<p>CEC Display Volume Up</p> <p>x = Output number (x = 1 ~ 5)</p>	52250x (x = 1 ~ 5)
52251x	<p>CEC Display Volume Down</p> <p>x = Output number (x = 1 ~ 5)</p>	52251x (x = 1 ~ 5)

TekFlex-85T Pro

79285 User Manual

7.6 System Function Commands

Command	Description	Command Example & Feedback
522520	Get the current firmware version	V1.0.0
522521	Restore factory default settings	522521
522522	System reboot	522522
522523	Get the IP address	IP: 192.168.0.178 Mask: 255.255.255.0 Gate: 192.168.0.1
530G00	Get HDBaseT Link Status x = 0 ~ 9 0 : Fail 9 : Excellent	53010x (x = 0 ~ 9) 53020x

7.7 Special Commands⁴

Command	Description	Command Example & Feedback
<code>+[x][y]:zzzz</code>	<p>Send ASCII command "zzzz" to a far-end device x = 0 ~ 2 0: Local 1: Output HDBT 1 2: Output HDBT 2</p> <p>y = Baud rate (1 ~ 5) 1: 115200 2: 57600 3: 38400 4: 19200 5: 9600</p> <p>zzzz = ASCII data to be sent (Up to 48 characters)</p> <p>Notes:</p> <ol style="list-style-type: none">1. When reading "\x", the two characters after "\x" will be converted to HEX automatically2. When typing "\\", only one "\" will be sent3. When reading "\r", "\r" will be converted to "0x0D" in HEX4. When reading "\n", "\n" will be converted to "0x0A" in HEX	<p><code>+[1][5]:123\r\x31\x3278</code></p> <p>123 1278</p>

⁴ **Note:** These special commands do not need termination for the strings

TekFlex-85T Pro

79285 User Manual

8. Firmware Upgrade

8.1 Switcher Firmware

Follow the steps below to upgrade the matrix switcher's firmware via the **GUI**:

1. Prepare the firmware upgrade file (.bin) on your PC
2. Log in to the web GUI on the PC
3. Select the Security tab and click the path box
4. Navigate to the upgrade file (.bin) on your computer
5. Double-click upgrade file (.bin) then it will return to the GUI interface, click Update.
6. Close GUI after the firmware upgrade, and reboot the switcher.

8.2 HDBaseT Receiver Firmware

Follow the steps below to upgrade the HDBaseT receiver's firmware via the **FW** port on the front panel:

1. Prepare the firmware upgrade file (.bin) on a PC or laptop and rename it to "FW_MERG.bin"
2. Power off the receiver and connect the receiver to the PC via a Micro-USB to USB-A cable
3. Power on the receiver, and the PC will automatically detect a flash drive titled "BOOTDISK"
4. Double-click the flash drive, and a file titled "READY.TXT" will be appear
5. Copy the upgrade file (.bin) to the "BOOTDISK" flash drive
6. Reopen the flash drive to check that the filename "READY.TXT" has changed to "SUCCESS.TXT". If this is the case, then the firmware has updated successfully. If this is not the case, then the firmware upgrade has failed. Check the name of the upgrade file (.bin), and then repeat the above steps to update
7. Remove the USB cable after the firmware upgrade is complete and reboot the receiver