

CB1-A Ceiling Box

78038 Installation Guide

Included in this Product Package:



CB1-A Ceiling
Box



Suspension
Cable Set (2)

Step 1: Remove Lid

- Unlatch and swing the lid up. You may need a wire hook to pull the lid up, or just tilt the box.
- Push the lid in towards the bottom and away from the metal hinges.
- Angle the lid so that you can pull it away from the metal hinge.
- Carefully remove the lid out from the ceiling box.

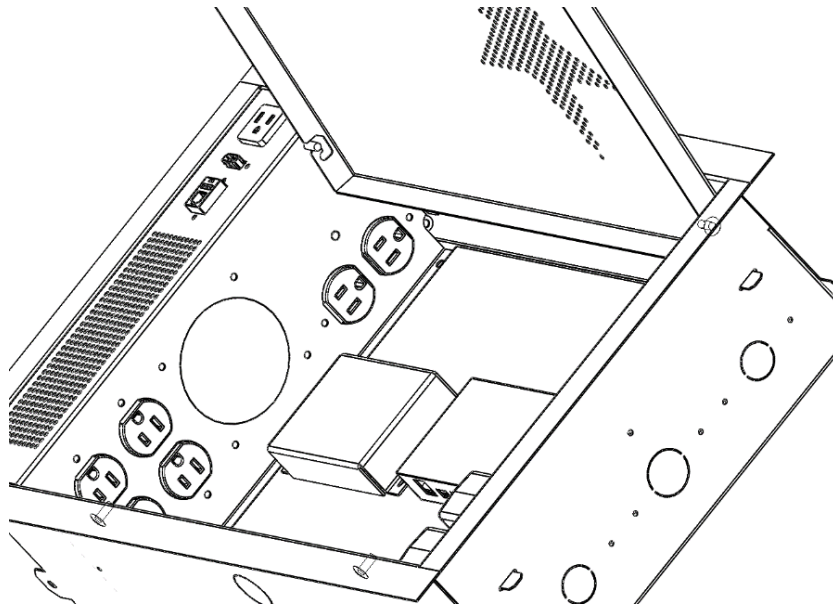

CB1-A Ceiling Box

78038 Installation Guide

Step 2: Select Appropriate Installation Location

It is important to mount the TEK CB1-A close enough to the projector for the 4' cables to reach, but not so close that you cannot fully open the ceiling box lid. The area above the ceiling box will need to be opened in order to install the supporting cables. Remove the ceiling tile and place it in a safe area.

Step 3: Cable Support Installation Options

Installing ceiling boxes without proper cable support is dangerous and can harm or kill someone. If you don't feel comfortable installing these cables, we suggest that you contact a professional who can do it for you.

Ceiling Truss

Most installations will use a ceiling truss and requires little effort. Simply loop the end of the braided cable around the truss and pull it tight through the eye of the cable. Do the same for the other 3 cables.

Wood Studded Ceiling

When installing with a wood studded ceiling, use four 1/4" x 3" eye lag screws. (*Note: These are not supplied with the ceiling box*). Drill a 1/8" hole into the stud and secure the screw into the wood. Place the end of the braided cable through the eye of the lag and pull it tight through the eye of the cable. Do the same for the other 3 cables.

Concrete Ceiling

For concrete ceiling installations, use four M6 Eye bolts. (*Note: These are not supplied with the ceiling box*). Using a 1/8" masonry drill bit, drill a hole into the concrete and secure the screw into the concrete by tapping it into place and tighten it down. Place the end of the braided cable through the eye of the lag and pull it tight through the eye of the cable. Do the same for the other three cables.

CB1-A Ceiling Box

78038 Installation Guide

Step 4: Installing A Kwik-Loc Cable Joiner

Kwik-Loc Cable Joiners are used to mount the CB1-A into the ceiling.

Step 4.1

First pass the end of the wire rope around the anchor point. This could be any of the above mentioned ceiling supports.

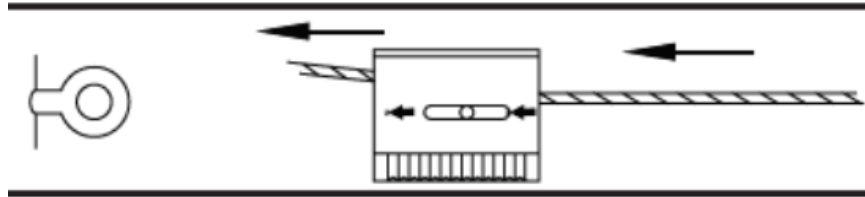

Step 4.2

Pass the end of the wire rope through the cable loop and pull the end tight around the anchor point.

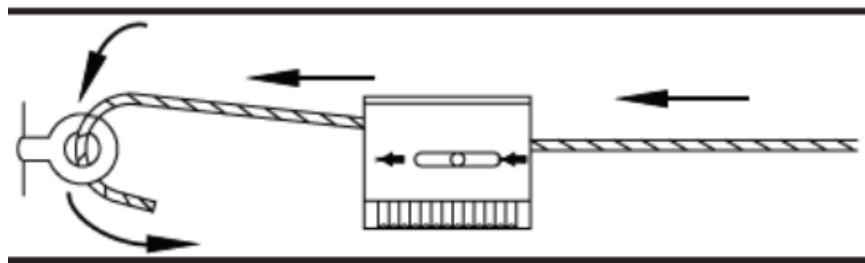

Step 4.3

Pull the adjustment pin back on the Kwik-Loc and pass the end of the wire rope through the cable input opening.

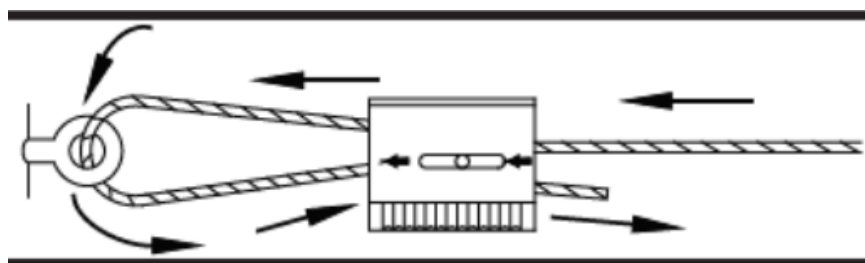

CB1-A Ceiling Box

78038 Installation Guide

Step 4.4

Place the ceiling box into the into the ceiling grid frame. Make certain that the direction of the ceiling box is correct before continuing.

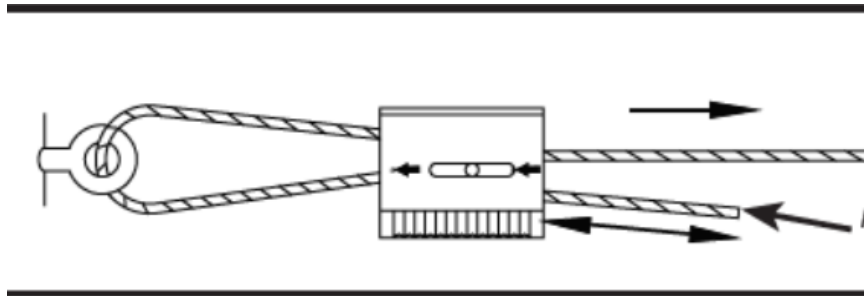

Step 4.5

Pull the end of the wire rope through the mounting hole on the ceiling box and loop it back through the Kwik-Loc cable outlet. Adjust the tightness of the cable so that it is not pulling the box up from the ceiling. Once completed, cut off the excess cable.

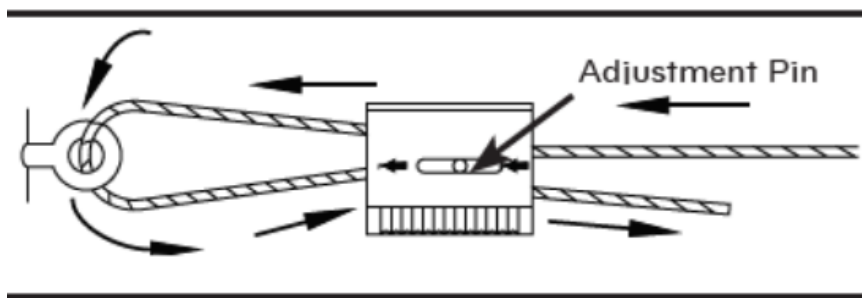

CB1-A Ceiling Box

78038 Installation Guide

Step 5: Electrical

On the main electrical side of the ceiling box is a junction box which contains the main power leads for the ceiling box. This junction box makes it easy to supply main power (120 volts at 60 Hz 15 amp only) to the ceiling box. The wires are 14 gauge stranded.

Wire color guide:

- Black (Line Hot)
- White (Neutral)
- Green (Building Ground)

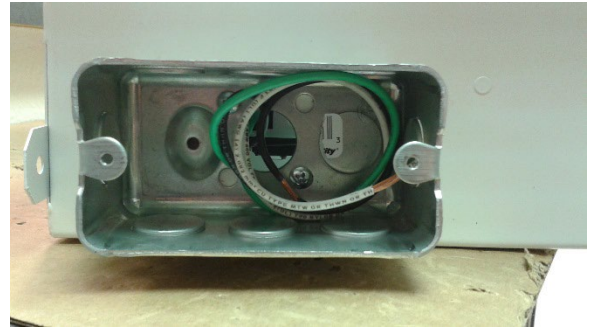

Step 6: Equipment Tray Installation

For ease of installation of equipment, a removable equipment tray comes attached to the inside base of the ceiling case. The equipment tray can be easily removed by loosening the four screws at the corners of tray and sliding the tray. Additional mounting screws are packaged separately within the ceiling cases. Installers may pre-wire the equipment tray prior to the CB1-A ceiling box installation.

The current equipment mounting holes allow for placement of TEKVOX equipment. Other equipment can easily be installed by drilling a 1/8" hole and using the supplied mounting screws. Thread-Forming Screws, Pan Head Phillips, 8-18 Threaded, 1/4" Length. Do not over tighten the mounting screws.



CB1-A Ceiling Box

78038 Installation Guide

Technical Specifications

AGENCY APPROVALS



4008930

PLENUM RATED:

Conforms to UL 2043: UL Standard for Safety Fire Test for Heat and Visible Smoke Release for Discrete Products and Accessories Installed in Air-Handling Spaces

SAFETY RATED:

Conforms to UL 60950-1: Information Technology Equipment - Safety and certified to CSA 22.2 60950-1: Safety of Information Technology Equipment

Model Number	78038
Size	23.75" x 14" x 5"
Weight	13 lbs
Gross Weight	50 lbs
Shipping Weight	17 lbs
Main Line Power	120V 60 Hz maximum 15 AmpsDrawings

CB1-A Ceiling Box

78038 Installation Guide

Diagram

